

Series 2600

- Combines a precision power supply, true current source, DMM, arbitrary waveform generator, V or I pulse generator with measurement, electronic load, and trigger controller—all in one instrument
- Contact check function ensures high integrity measurements
- 10,000 readings/s and 5,500 source-measure points/s to memory provide faster test times
- The embedded Test Script Processor (TSP™) offers unparalleled system automation and two to four times the test throughput of competitive products in I-V functional test applications
- Family of products offers wide dynamic range: 1pA to 10A and 1μV to 200V
- TSP-Link™ master/slave connection seamlessly integrates multiple Series 2600 SourceMeter channels into a system that can be programmed and controlled as a single instrument
- Free Test Script Builder software simplifies creating powerful test scripts for programming custom test functions
- Free LabTracer™ 2.0 software available for curve tracing and fast, easy startup
- Each SourceMeter channel is electrically isolated for high integrity measurements and wiring flexibility
- Industry's highest SMU rack density for automated test applications

System SourceMeter® Multi-Channel I-V Test Solutions

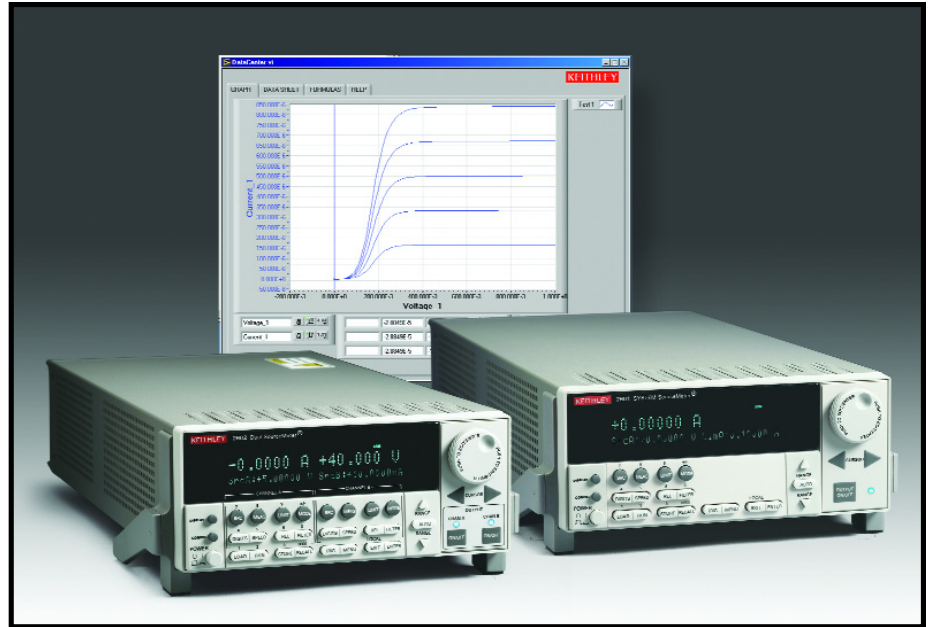

Series 2600 System SourceMeter instruments offer electronic component and semiconductor device manufacturers a scalable, high throughput, highly cost-effective solution for precision DC, pulse, and low frequency AC source-measure testing. Building on the tightly integrated source-measure technology originally developed for Keithley's popular Series 2400 SourceMeter line, Series 2600 instruments provide from two to four times the test speed of competitive solutions in I-V functional test applications. They also offer higher source-measure channel density and a significantly lower cost of ownership than competing products. The analog-to-digital converters provide simultaneous I and V measurements in less than 100μs (10,000 rdgs/s) and source-measure sweep speeds of less than 200μs per point (5,500 points/s). This high speed source-measure capability, plus advanced automation features and time-saving software tools make Series 2600 SourceMeter instruments an ideal solution for I-V testing of a wide range of devices.

System scalability without a mainframe

Series 2600 instruments incorporate an innovative technology that makes it possible to create multi-channel I-V test systems economically, but without sacrificing test throughput. TSP-Link is a high speed system expansion interface, which test system builders can use to connect multiple

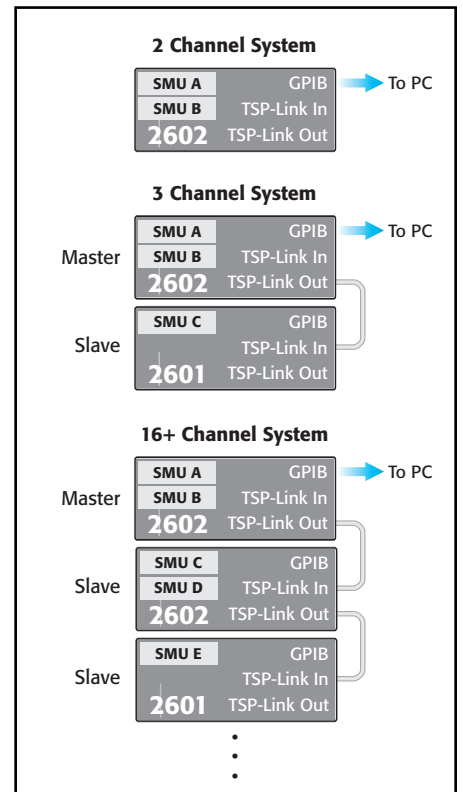

TSP-Link makes it easy to scale the system's channel count to match the application.

1.888.KEITHLEY (U.S. only)

www.keithley.com

KEITHLEY

A GREATER MEASURE OF CONFIDENCE

Scalable, integrated source and measure solutions

SOURCE AND MEASURE

Series 2600

Ordering Information

2601	Single-channel System SourceMeter Instrument (High Current)
2602	Dual-channel System SourceMeter Instrument (High Current)
2611	Single-channel System SourceMeter Instrument (200V)
2612	Dual-channel System SourceMeter Instrument (200V)

ACCESSORIES SUPPLIED

2600-IAC Safety Interlock Adapter Connector (one supplied with 2611/2612)
 Test Script Builder software
 LabTracer Software (downloadable)
 IVI/VISA drivers for Visual Basic, VC/C++, LabVIEW, TestPoint, and LabWindows™/CVI
 Mating screw terminal connectors with strain relief and covers (2600-Kit)
 TSP-Link cable (CA-180-3A)

Factory and custom TSP test scripts

The Test Script Processor is programmed with a simple BASIC-style programming language that runs in real time on the instrument. Keithley provides built-in test scripts for:

- Sweeping
- Pulsing
- Waveform generation
- Common component tests like binary search, V_F , V_{TH} , LIV (light intensity/current/voltage)

A number of test scripts are included in the instrument, while others can be downloaded at no charge from www.keithley.com. These pre-written factory test scripts can be used as provided or easily customized for a given application, so production users can get their systems up and running faster than ever before.

Users can also create custom test scripts in several different ways, including a programming tool called Test Script Builder. Custom scripts can be downloaded from the PC to the master SourceMeter unit and saved in non-volatile memory. All four models provide 16 megabytes of non-volatile memory for storing up to 50,000 lines of TSP code and more than 100,000 readings.

1.888.KEITHLEY (U.S. only)

www.keithley.com

System SourceMeter® Multi-Channel I-V Test Solutions

Series 2600 instruments in a master/slave configuration. Once connected, all the Series 2600 instruments in a system can be programmed and operated under the control of the master unit, just as if they were housed in the same chassis. By eliminating the need for a chassis/mainframe, the TSP-Link provides virtually unlimited flexibility to scale a test system's channel count up or down as the application requires, while ensuring seamless integration.

New capabilities for increasing test speed and lowering test cost

The Test Script Processor (TSP)

Any Series 2600-based system can run high speed, embedded test scripts on the master unit's Test Script Processor (TSP), the other major new technology on which the Series 2600 is based. The test sequence is processed and run on the embedded computer in the instrument, rather than from an external PC controller, so delays due to GPIB traffic congestion are eliminated. TSP test scripts allow throughput gains of up to 10x over equivalent PC-based programs controlling the same instruments via GPIB. TSP test scripts can be loaded and run from the front panel or over the system's GPIB interface. A single TSP test script, running on the master unit, can control all the SourceMeter channels in the system and acquire data from any Series 2600 instrument connected to the TSP-Link, which supports connections for up to 64 Series 2600 instruments.

TSP for advanced automation

A Series 2600-based system can stand alone as a complete measurement and automation solution for semiconductor device or component testing, with the master unit controlling sourcing, measuring, pass/fail decisions, test sequence flow control, binning, and the component handler or prober. In contrast with existing embedded test sequencers for instrumentation, the TSP test scripts offer far greater programming flexibility, including support for:

- Instrument command queuing
- Modular subroutines with passable parameters
- Pass/fail and limit testing
- A wide range of math operations
- Flexible branching and looping capability
- Flexible external triggering
- Intelligent digital I/O read and write capability
- RS-232 communication

ACCESSORIES AVAILABLE

CABLES AND CONNECTORS

2600-BAN	Banana Test Leads/Adapter Cable. For a single Series 2600 SMU channel
2600-KIT	Extra screw terminal connector, strain relief, and cover for a single SourceMeter channel (one supplied with 2601/2611, two with 2602/2612)
2600-TRIAx	Triax Adapter. For a single Series 2600 SourceMeter (two needed for use with 2602/2612)
7078-TRX-*	3-Slot, Low Noise Triax Cable. For use with 2600-TRIAx Adapter
8606	High Performance Modular Probe Kit. For use with 2600-BAN
SC-200	Shielded Twisted Pair Cable. Recommended for general-purpose use with Series 2600 System SourceMeter instruments
2600-IAC	Safety Interlock Adapter Connector (one supplied with 2611/2612)

DIGITAL I/O, TRIGGER LINK AND TPS-LINK

2600-TLINK	Digital I/O to TLINK Adapter Cable, 1m
CA-126-1	Digital I/O and Trigger Cable, 1.5m
CA-180-3A	CAT5 Crossover Cable for TSP-Link (one supplied)

GPIB INTERFACES AND CABLES

7007-1	Double Shielded GPIB Cable, 1m (3.3 ft.)
7007-2	Double Shielded GPIB Cable, 2m (6.6 ft.)
KPCI-488	GPIB/IEEE-488 Interface Board for the PCI Bus
KUSB-488	GPIB/IEEE-488 Interface Module for the USB Bus

SWITCHING

7002-HD	High Density Switch Mainframe
7002-HD-MTX1	Differential 6x32 Matrix Card
7002-HD-MUX1	Differential Quad 1x40 Multiplexer Card

RACK MOUNT KITS

4299-1	Single Rack Mount Kit with front and rear support
4299-2	Dual Rack Mount Kit with front and rear support

SOFTWARE

LabTracer™ 2.0 Curve Tracing Software (downloadable)

EXTENDED WARRANTIES

2601-EW	1 Year Extended Warranty for Model 2601
2602-EW	1 Year Extended Warranty for Model 2602
2611-EW	1 Year Extended Warranty for Model 2611
2612-EW	1 Year Extended Warranty for Model 2612

KEITHLEY

A GREATER MEASURE OF CONFIDENCE

Series 2600

System SourceMeter® Multi-Channel I-V Test Solutions

Third-generation SMU design ensures faster test times

The Series 2600's new SMU design enhances test speed in several ways. For example, while earlier designs used a parallel current ranging topology, the Series 2600 uses a series ranging topology (patent pending), which provides faster and smoother range changes and outputs that settle more quickly. It also allows the current output limit to be programmed independently of the measurement current range for fast charging of capacitive loads and more intuitive operation during bench use.

Each Series 2600 SourceMeter channel offers a highly flexible, four-quadrant source coupled with precision voltage and current meters/limiters. Each channel can be configured as a:

- Precision power supply (up to 200V and 3A DC/10A pulsed output with 1pA readback resolution)
- True current source
- DMM (DCV, DCI, ohms, power, with 5½-digit resolution)
- Power V or I pulse generator (Pulse width: 200µs and longer—source and measure)
- Power V or I waveform generator (20-point sine wave up to 400Hz in a TSP test script)
- Electronic load (with sink mode capability)

High speed and precision A/Ds with simultaneous source-readback

All Series 2600 instruments provide four-quadrant operation and can be connected in series or in parallel to extend their dynamic range. In the first and third quadrants, they operate as a source, delivering power to a load. In the second and fourth quadrants, they operate as a sink, dissipating power internally. They measure voltage and current simultaneously with up to 5½-digit resolution, and they display voltage, current, resistance, or power readings.

Two analog-to-digital converters per channel (one for I, one for V) can run simultaneously, providing precise source-readback without sacrificing test throughput. These A/D converters offer the flexibility of programmable integration rates, allowing the user to optimize for either high speed (>10,000 rdgs/s at 0.001 NPLC setting) or for high resolution (up to 24 bits at 10 NPLC setting) to make high accuracy measurements.

Digital I/O Interface

A back panel port on every Series 2600 instrument provides 14 bits of universal digital I/O to link the instrument to a variety of popular handlers for sorting and binning components after testing. These I/O lines are also backward-compatible with Keithley's earlier Trigger Link instrument triggering technology. These lines simplify integrating Series 2600 instruments into systems that employ other external instrumentation, including Series 2400 SourceMeter instruments, Series 7000 switch mainframes, and Series 2700 Integra data acquisition/multimeter systems.

Built-in Contact Check Function

The Contact Check function makes it simple to verify good connections quickly and easily before an automated test sequence begins. This eliminates measurement errors and false product failures associated with contact fatigue, breakage, contamination, loose or broken connection, relay failures, etc.

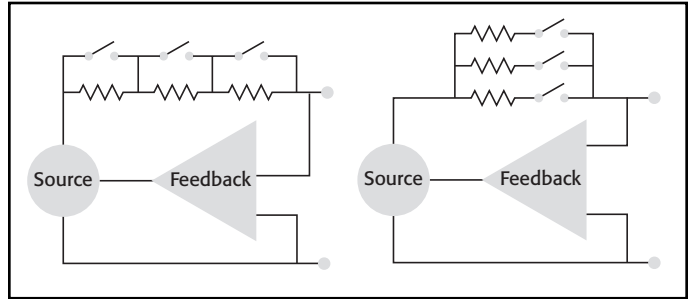

Series vs. parallel ranging topologies

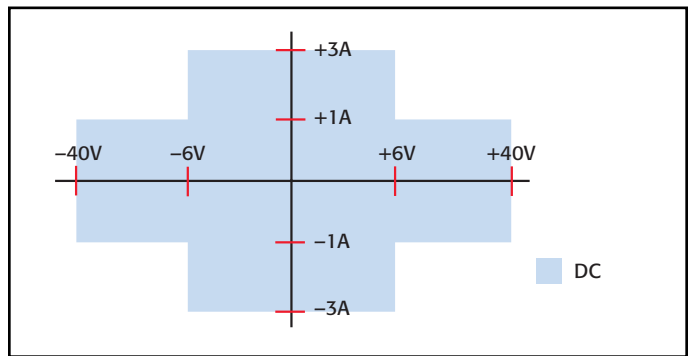

Models 2601 and 2602 I-V capability

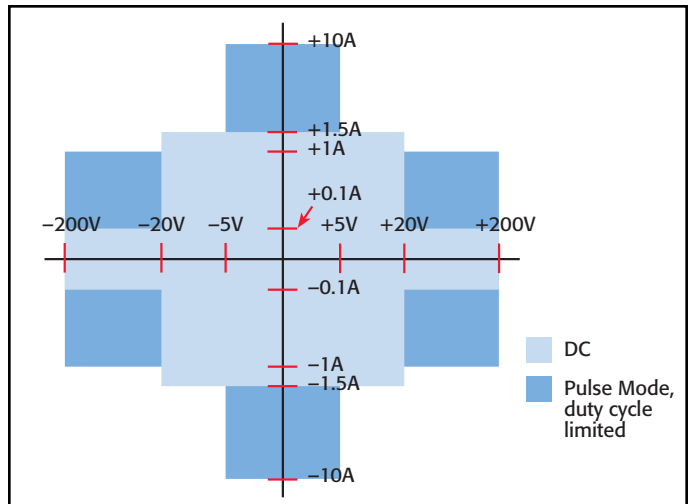

Models 2611 and 2612 I-V capability

1.888.KEITHLEY (U.S. only)

www.keithley.com

KEITHLEY

A GREATER MEASURE OF CONFIDENCE

Scalable, integrated source and measure solutions

SOURCE AND MEASURE

Series 2600

System SourceMeter® Multi-Channel I-V Test Solutions

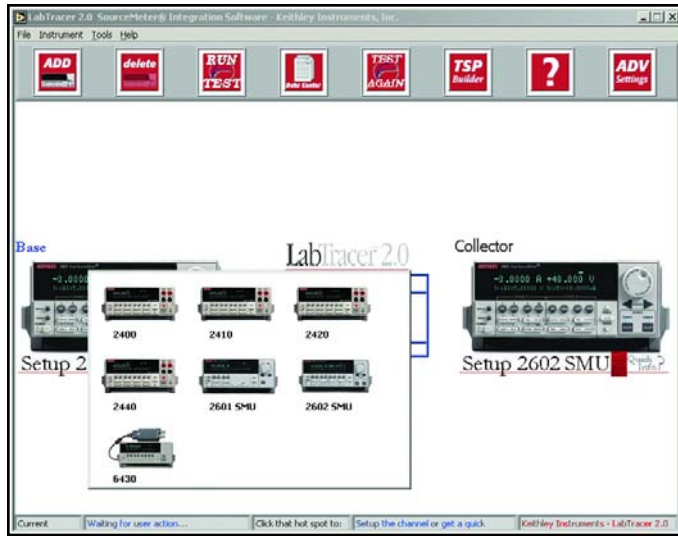

Graphical instrument setup. LabTracer 2.0 supports up to eight Series 2600 SourceMeter channels. Model 2400 and Model 2410 SourceMeter instruments are also supported for extended voltage capability. Drop-down menus in LabTracer 2.0's instrument setup window allow configuring any channel of a SourceMeter instrument for fixed point or sweeping operation. Once the instrument is configured, a single key press is all it takes to execute a test.

The screenshot shows the 'LabTracer 2.0 DataCenter' spreadsheet panel. It has tabs for 'GRAPH', 'DATA SHEET', 'FORMULAS', and 'HELP'. The 'DATA SHEET' tab is active, showing a table with columns: 'Base Voltage_1 (1)', 'Collector Voltage_2', 'Collector Current_2', 'Base Voltage_1 (2)', 'Collector Voltage_2', 'Collector Current_2', and 'Base V'. The table contains 23 rows of data. Below the table are 'Save Data' and 'Clear Data' buttons.

	Base Voltage_1 (1)	Collector Voltage_2	Collector Current_2	Base Voltage_1 (2)	Collector Voltage_2	Collector Current_2	Base V
0	0.97316	-0.00052714	-1.8752e-06	0.46943	-0.00024104	-3.1674e-06	0.486
1	0.46233	0.049462	-4.7247e-07	0.5196	0.048891	-9.8747e-07	0.536
2	0.53208	0.098843	3.2157e-06	0.56903	0.099375	4.0126e-05	0.584
3	0.57714	0.15007	3.8394e-05	0.6134	0.14994	9.7393e-05	0.629
4	0.61006	0.20084	8.6117e-05	0.64241	0.1999	0.00032104	0.657
5	0.62242	0.24994	0.0001494	0.65388	0.24992	0.00047325	0.667
6	0.62524	0.29996	0.00016036	0.6562	0.29996	0.00052748	0.670
7	0.62606	0.34977	0.00016329	0.657	0.35024	0.0005366	0.670
8	0.62619	0.39973	0.00016361	0.65755	0.39979	0.00053812	0.670
9	0.62586	0.44923	0.00016465	0.65688	0.44988	0.0005386	0.671
10	0.62588	0.49961	0.00016433	0.65671	0.50018	0.00053951	0.670
11	0.62623	0.54981	0.00016437	0.65709	0.54994	0.0005383	0.670
12	0.62615	0.60035	0.00016422	0.65724	0.60011	0.00053982	0.671
13	0.62583	0.65031	0.00016402	0.65677	0.65002	0.00054	0.671
14	0.62586	0.69965	0.00016402	0.65683	0.6997	0.00054036	0.670
15	0.62562	0.75001	0.00016444	0.65714	0.74993	0.0005401	0.670
16	0.62608	0.79994	0.00016436	0.65712	0.79989	0.00053996	0.671
17	0.62589	0.85012	0.00016464	0.65682	0.84913	0.00054011	0.671
18	0.62616	0.9013	0.00016515	0.65682	0.90003	0.00054033	0.670
19	0.6262	0.95005	0.00016478	0.65624	0.94981	0.00054078	0.670
20	0.62589	1	0.00016437	0.65708	1.0001	0.00054113	0.671
21	0.62593	1.05	0.00016424	0.6573	1.0511	0.00054078	0.670
22	0.62561	1.0998	0.00016439	0.65681	1.0999	0.00054108	0.670
23	0.62615	1.1497	0.00016454	0.65654	1.1499	0.00054244	0.670

Spanning I-V test applications from R&D to functional test

The Series 2600 SourceMeter Instruments provide simple-to-use yet powerful solutions for R&D testing. At the same time, they offer the speed and reliability needed for volume production testing.

High power and simplicity for R&D applications

In R&D and device characterization environments, Series 2600 instruments offer high testing versatility for both interactive and automated testing. The free downloadable LabTracer 2.0 software allows users to configure and control up to eight Series 2600 or 2400 SourceMeter channels quickly and easily for curve tracing or device characterization. It provides a simple graphical user interface for setup, control, data acquisition, and graphing of DUT data from SourceMeter instruments. When used together, LabTracer and SourceMeter instruments offer lab users a powerful, easy-to-use, and economical alternative to chassis-based solutions.

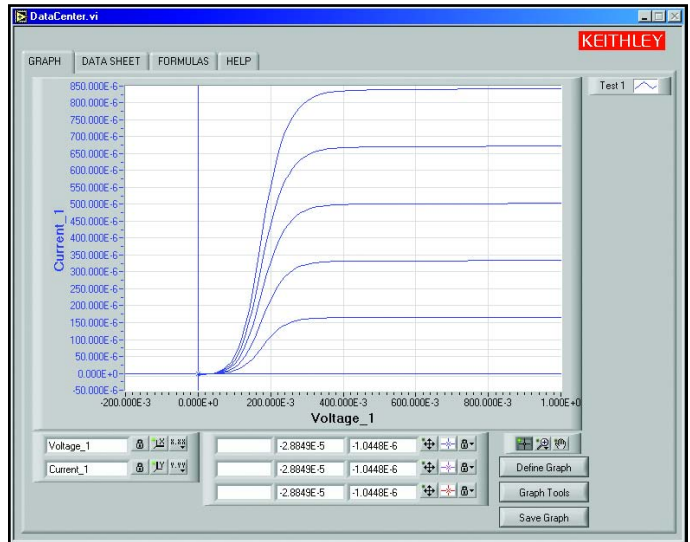

Once a test is complete, data is displayed in the spreadsheet panel and graphing panel. Measurement data can be manipulated in the spreadsheet by applying a formula to the results. For more detailed analysis, data can also be exported to Microsoft® Excel with a simple cut and paste.

Series 2600

System SourceMeter® Multi-Channel I-V Test Solutions

Dramatic throughput improvements for production test

Series 2600 instruments help component manufacturers improve their test throughput dramatically, as well as provide test solutions that can handle today's devices, which often have higher pin counts and more analog circuitry than earlier designs. In the past, manufacturers have been forced by the lack of optimized test solutions for multi-channel source-measure applications to choose between bulky, expensive mainframe-based systems, slow instrument-based systems employing PC control, or fast instrument-based systems that require complex development. The Series 2600 offers:

- The highest density available in any SMU-based system to address growing pin counts.
- The industry's fastest throughput, which helps reduce the cost of test. The speed of the onboard processor and TSP test scripts, combined with the tight triggering synchronization offered by the TSP-Link bus, makes high speed parallel testing practical.
- A lower capital investment. By eliminating the need for a mainframe/chassis, they allow test engineers to configure a readily scalable system at a significantly lower cost per channel than other solutions.

Test Script Builder software

Test Script Builder is a free software tool that is provided with all Series 2600 SourceMeter instruments to help users create, modify, debug, and store TSP test scripts. It provides a project/file manager window to store and organize test scripts, a text-sensitive program editor (like Visual Basic) to create and modify test TSP code, and an immediate instrument control window to send GPIB commands and receive data from the instrument. The immediate window allows viewing the output of a given test script and simplifies debugging.

TYPICAL APPLICATIONS

- **I-V functional test and characterization of a wide range of devices, including:**
 - Discrete and passive components
 - Two-leaded – Resistors, disk drive heads, metal oxide varistors (MOV), diodes, zener diodes, sensors, capacitors, thermistors
 - Three-leaded – Small signal bipolar junction transistors (BJTs), field-effect transistors (FETs), and more
 - Parallel test – Two- and three-leaded component arrays
 - Simple ICs – Optos, drivers, switches, sensors
- **Integrated devices – Small Scale Integrated (SSI) and Large Scale Integrated (LSI).**
 - Analog ICs
 - Radio frequency integrated circuits (RFICs)
 - Application specific integrated circuits (ASICs)
 - System on a chip (SOC) devices
- **Optoelectronic devices such as light-emitting diodes (LEDs), laser diodes, high brightness LEDs (HBLEDs), vertical cavity surface-emitting lasers (VCSELs), displays**
- **R&D and device characterization of these types of devices**

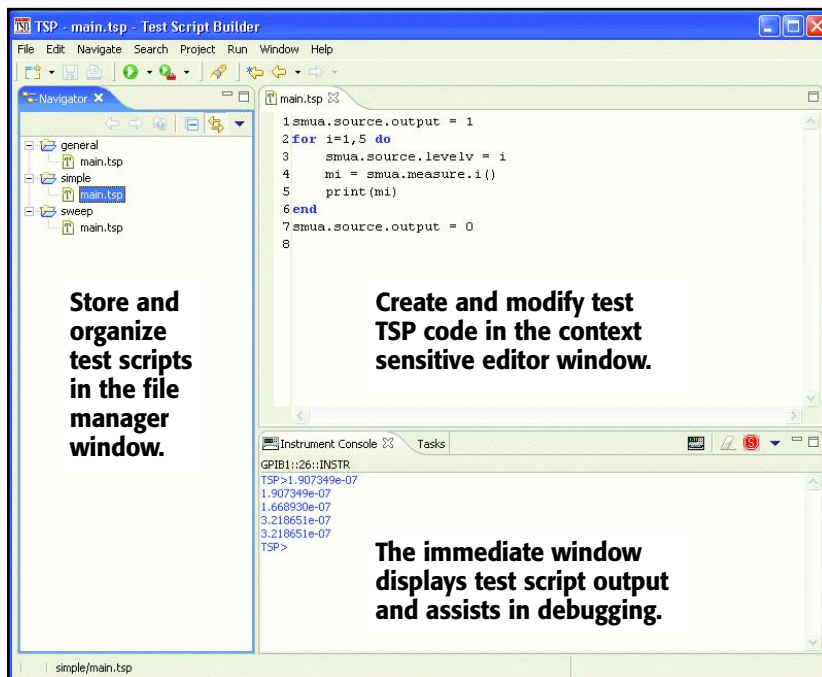

1.888.KEITHLEY (U.S. only)

www.keithley.com

KEITHLEY

A GREATER MEASURE OF CONFIDENCE

Scalable, integrated source and measure solutions

SOURCE AND MEASURE

2601 2602

System SourceMeter® Multi-Channel I-V Test Solutions

SPECIFICATION CONDITIONS

This document contains specifications and supplemental information for the Models 2601 and 2602. Specifications are the standards against which the Models 2601 and 2602 are tested. Upon leaving the factory the 2601 and 2602 meet these specifications. Supplemental and typical values are non-warranted, apply at 23°C, and are provided solely as useful information.

The source and measurement accuracies are specified at the SourceMeter CHANNEL A (2601 and 2602) or SourceMeter CHANNEL B (2602) terminals under the following conditions:

1. 23°C ± 5°C, <70% relative humidity.
2. After 2 hour warm-up.
3. Speed normal (1 NPLC).
4. A/D auto-zero enabled.
5. Remote sense operation or properly zeroed local operation.
6. Calibration period = 1 year.

SOURCE SPECIFICATIONS

VOLTAGE PROGRAMMING ACCURACY¹

RANGE	PROGRAMMING RESOLUTION	ACCURACY (1 Year) 23°C ±5°C ±(% rdg. + volts)	TYPICAL NOISE (peak-peak) 0.1Hz–10Hz
100.000 mV	5 μV	0.02% + 250 μV	20 μV
1.00000 V	50 μV	0.02% + 400 μV	50 μV
6.00000 V	50 μV	0.02% + 1.8 mV	100 μV
40.0000 V	500 μV	0.02% + 12 mV	500 μV

TEMPERATURE COEFFICIENT (0°–18°C & 28°–50°C): ±(0.15 × accuracy specification)/°C.

MAXIMUM OUTPUT POWER AND SOURCE/SINK LIMITS²: 40.4W per channel maximum. ±40.4V @ ±1.0A, ±6.06V @ ±3.0A, four quadrant source or sink operation.

VOLTAGE REGULATION: Line: 0.01% of range. Load: ±(0.01% of range + 100μV).

NOISE 10Hz–20MHz (peak-peak): 25mV typical into a resistive load.

CURRENT LIMIT/COMPLIANCE³: Bipolar current limit (compliance) set with single value. Minimum value is 10nA. Accuracy same as current source.

OVERSHOOT: <±(0.1% + 10mV) typical (step size = 10% to 90% of range, resistive load, maximum current limit/compliance).

GUARD OFFSET VOLTAGE: <10mV typical (I_{out} ≤ 100mA).

CURRENT PROGRAMMING ACCURACY

RANGE	PROGRAMMING RESOLUTION	ACCURACY (1 Year) 23°C ±5°C ±(% rdg. + amps)	TYPICAL NOISE (peak-peak) 0.1Hz–10Hz
100.000 nA	1 pA	0.06% + 100 pA	5 pA
1.00000 μA	10 pA	0.03% + 600 pA	25 pA
10.0000 μA	100 pA	0.03% + 2 nA	50 pA
100.000 μA	1 nA	0.03% + 30 nA	3 nA
1.00000 mA	10 nA	0.03% + 200 nA	5 nA
10.0000 mA	100 nA	0.03% + 3 μA	200 nA
100.000 mA	1 μA	0.03% + 20 μA	500 nA
1.00000 A ²	10 μA	0.05% + 900 μA	60 μA
3.00000 A ²	10 μA	0.06% + 1.5 mA	150 μA

TEMPERATURE COEFFICIENT (0°–18°C & 28°–50°C): ±(0.15 × accuracy specification)/°C.

MAXIMUM OUTPUT POWER AND SOURCE/SINK LIMITS²: 40.4W per channel maximum. ±1.01A @ ±40.0V, ±3.03A @ ±6.0V, four quadrant source or sink operation.

CURRENT REGULATION: Line: 0.01% of range. Load: ±(0.01% of range + 100pA).

VOLTAGE LIMIT/COMPLIANCE⁴: Bipolar voltage limit (compliance) set with a single value. Minimum value is 10mV. Accuracy same as voltage source.

OVERSHOOT: <0.1% typical (step size = 10% to 90% of range, resistive load; see CURRENT SOURCE OUTPUT SETTLING TIME for additional test conditions).

ADDITIONAL SOURCE SPECIFICATIONS

TRANSIENT RESPONSE TIME: <70μs for the output to recover to 0.1% for a 10% to 90% step change in load.

VOLTAGE SOURCE OUTPUT SETTLING TIME: Time required to reach 0.1% of final value, when changing from 10% to 90% of range, after source level command is processed on a fixed range.

100mV, 1V Ranges: <50μs typical.

6V Range: <100μs typical.

40V Range: <150μs typical⁵

CURRENT SOURCE OUTPUT SETTLING TIME: Time required to reach 0.1% of final value, when changing from 10% to 90% of range, after source level command is processed on a fixed range. Values below for I_{out} · R_{load} = 2V unless noted.

3A–10mA Ranges: <80μs typical (current less than 2.5A, R_{load} >1.5Ω).

1mA Range: <100μs typical.

100μA Range: <150μs typical.

10μA Range: <500μs typical.

1μA Range: <2.5ms typical.

100nA Range: <25ms typical.

DC FLOATING VOLTAGE: Output can be floated up to ±250VDC from chassis ground.

REMOTE SENSE OPERATING RANGE⁶:

Maximum voltage between HI and SENSE HI = 3V.

Maximum voltage between LO and SENSE LO = 3V.

VOLTAGE OUTPUT HEADROOM:

40V Range: Max. output voltage = 42V – total voltage drop across source leads (maximum 1Ω per source lead).

6V Range: Max. output voltage = 8V – total voltage drop across source leads.

OVER TEMPERATURE PROTECTION: Internally sensed temperature overload puts unit in standby mode.

VOLTAGE SOURCE RANGE CHANGE OVERSHOOT: Overshoot into a 100kΩ load, 20MHz BW, 300mV typical.

CURRENT SOURCE RANGE CHANGE OVERSHOOT: <5% + 300mV/R_{load} of larger range typical. (See CURRENT SOURCE OUTPUT SETTLING TIME for additional test conditions.)

NOTES

1. Add 50μV to source accuracy specifications per volt of HI lead drop.
2. Full power source operation regardless of load to 30°C ambient. Above 30°C and/or power sink operation, refer to Section 8 – Operating Boundaries in the Series 2600 Reference Manual for additional power derating information.
3. For sink mode operation (quadrants II and IV), add 12% of limit range and ±0.02% of limit setting to corresponding current limit accuracy specifications. For 1A range add an additional 40mA of uncertainty.
4. For sink mode operation (quadrants II and IV), add 10% of compliance range and ±0.02% of limit setting to corresponding voltage source specification. For 100mV range add an additional 60mV of uncertainty.
5. Add 150μs when measuring on the 1A range.

1.888.KEITHLEY (U.S. only)

www.keithley.com

KEITHLEY

A GREATER MEASURE OF CONFIDENCE

2601 2602

System SourceMeter® Multi-Channel I-V Test Solutions

METER SPECIFICATIONS

VOLTAGE MEASUREMENT ACCURACY¹

RANGE	DISPLAY RESOLUTION ³	INPUT RESISTANCE	ACCURACY (1 Year) 23°C ±5°C ±(% rdg. + volts)
100.000 mV	1 μV	>10 GΩ	0.015% + 150 μV
1.00000 V	10 μV	>10 GΩ	0.015% + 200 μV
6.00000 V	10 μV	>10 GΩ	0.015% + 1 mV
40.0000 V	100 μV	>10 GΩ	0.015% + 8 mV

TEMPERATURE COEFFICIENT (0°–18°C & 28°–50°C): ±(0.15 × accuracy specification)/°C.

CURRENT MEASUREMENT ACCURACY

RANGE	DISPLAY RESOLUTION ³	VOLTAGE BURDEN ²	ACCURACY (1 Year) 23°C ±5°C ±(% rdg. + amps)
100.000 nA	1 pA	<1 mV	0.05% + 100 pA
1.00000 μA	10 pA	<1 mV	0.025% + 300 pA
10.0000 μA	100 pA	<1 mV	0.025% + 1.5 nA
100.000 μA	1 nA	<1 mV	0.02% + 25 nA
1.00000 mA	10 nA	<1 mV	0.02% + 200 nA
10.0000 mA	100 nA	<1 mV	0.02% + 2.5 μA
100.000 mA	1 μA	<1 mV	0.02% + 20 μA
1.00000 A	10 μA	<1 mV	0.03% + 1.5 mA
3.00000 A	10 μA	<1 mV	0.05% + 3.5 mA

TEMPERATURE COEFFICIENT (0°–18°C & 28°–50°C): ±(0.15 × accuracy specification)/°C.

CONTACT CHECK⁴

SPEED	MAXIMUM MEASUREMENT TIME TO MEMORY FOR 60Hz (50Hz) ⁴	ACCURACY (1 Year) 23°C ±5°C ±(%rdg. + ohms)
FAST	1 (1.2) ms	5% + 10
MEDIUM	4 (5) ms	5% + 1
SLOW	36 (42) ms	5% + 0.3

ADDITIONAL METER SPECIFICATIONS

LOAD IMPEDANCE: Stable into 10,000pF typical.

COMMON MODE VOLTAGE: 250VDC.

COMMON MODE ISOLATION: >1GΩ, <4500pF.

OVERRANGE: 101% of source range, 102% of measure range.

MAXIMUM SENSE LEAD RESISTANCE: 1kΩ for rated accuracy.

SENSE INPUT IMPEDANCE: >10GΩ.

NOTES

1. Add 50μV to source accuracy specifications per volt of HI lead drop.
2. Four-wire remote sense only.
3. Applies when in single channel display mode.
4. Includes measurement of SENSE HI to HI and SENSE LO to LO contact resistances.

GENERAL

HOST INTERFACES: Computer control interfaces.

IEEE-488: IEEE-488.1 compliant. Supports IEEE-488.2 common commands and status model topology.

RS-232: Baud rates from 300 bps to 115200 bps. Programmable number of data bits, parity type, and flow control (RTS/CTS hardware or none). When not programmed as the active host interface, the SourceMeter can use the RS-232 interface to control other instrumentation.

EXPANSION INTERFACE: The TSP-Link expansion interface allows TSP enabled instruments to trigger and communicate with each other.

Cable Type: Category 5e or higher LAN crossover cable.

Length: 3 meters maximum between each TSP enabled instrument.

DIGITAL I/O INTERFACE:

Connector: 25-pin female D.

Input/Output Pins: 14 open drain I/O bits.

Absolute Maximum Input Voltage: 5.25V

Absolute Minimum Input Voltage: -0.25V

Maximum Logic Low Input Voltage: 0.7V +850μA max.

Minimum Logic High Input Voltage: 2.1V +570μA.

Maximum Source Current (flowing out of Digital I/O bit): +960μA.

Maximum Sink Current @ Maximum Logic Low Voltage (0.7V): -5.0mA.

Absolute Maximum Sink Current (flowing into Digital I/O pin): -11mA.

5V Power Supply Pin: Limited to 600mA, solid state fuse protected.

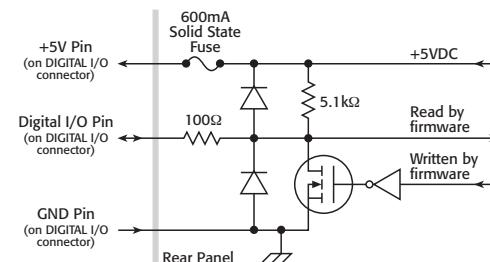

Output Enable Pin: Active high input pulled down internally to ground with 10kΩ resistor. When the Output Enable input function has been activated, each SourceMeter channel will not turn on unless the Output Enable pin is driven to >2.1V (nominal current = 2.1V / 10kΩ = 210μA).

POWER SUPPLY: 100V to 240VAC, 50–60Hz (manual setting), 240VA max.

COOLING: Forced air. Side intake and rear exhaust. One side must be unobstructed when rack mounted.

WARRANTY: 1 year.

EMC: Conforms to European Union Directive 89/336/EEC, EN 61326-1.

SAFETY: Conforms to European Union Directive 73/23/EEC, EN 61010-1, and UL 61010-1.

DIMENSIONS: 89mm high × 213mm wide × 460mm deep (3½ in × 8½ in × 17½ in). Bench Configuration (with handle & feet): 104mm high × 238mm wide × 460mm deep (4¼ in × 9½ in × 17½ in).

WEIGHT: 2601: 4.75kg (10.4 lbs). 2602: 5.50kg (12.0 lbs).

ENVIRONMENT: For indoor use only.

Altitude: Maximum 2000 meters above sea level.

Operating: 0°–50°C, 70% R.H. up to 35°C. Derate 3% R.H./°C, 35°–50°C.

Storage: -25°C to 65°C.

1.888.KEITHLEY (U.S. only)

www.keithley.com

KEITHLEY

2611 2612

System SourceMeter® Multi-Channel I-V Test Solutions

SPECIFICATION CONDITIONS

This document contains specifications and supplemental information for the Models 2611 and 2612. Specifications are the standards against which the Models 2611 and 2612 are tested. Upon leaving the factory the 2611 and 2612 meet these specifications. Supplemental and typical values are non-warranted, apply at 23°C, and are provided solely as useful information.

The source and measurement accuracies are specified at the SourceMeter CHANNEL A (2611 and 2612) or SourceMeter CHANNEL B (2612) terminals under the following conditions:

- 23°C ± 5°C, <70% relative humidity.
- After 2 hour warm-up.
- Speed normal (1 NPLC).
- A/D auto-zero enabled.
- Remote sense operation or properly zeroed local sense operation.
- Calibration period = 1 year.

SOURCE SPECIFICATIONS

VOLTAGE PROGRAMMING ACCURACY¹

RANGE	PROGRAMMING RESOLUTION	ACCURACY (1 Year) 23°C ±5°C ±(% rdg. + volts)	NOISE (peak-peak) 0.1Hz–10Hz
200.000 mV	5 μV	0.02% + 375 μV	20 μV
2.00000 V	50 μV	0.02% + 600 μV	50 μV
20.0000 V	500 μV	0.02% + 5 mV	300 μV
200.000 V	5 mV	0.02% + 50 mV	2 mV

TEMPERATURE COEFFICIENT (0°–18°C & 28°–50°C): ±(0.15 × accuracy specification)°C.

MAXIMUM OUTPUT POWER AND SOURCE/SINK LIMITS²: 30.603W per channel maximum.
±20.2V @ ±1.515A, ±202V @ ±101mA, four quadrant source or sink operation.

VOLTAGE REGULATION: Line: 0.01% of range. Load: ±(0.01% of range + 100μV).

NOISE 10Hz–20MHz: <5mV RMS typical, 20V range, 1A limit.

CURRENT LIMIT/COMPLIANCE³: Bipolar current limit (compliance) set with single value. Minimum value is 10nA. Accuracy same as current source.

OVERSHOOT: <±(0.1% + 10mV) typical (step size = 10% to 90% of range, resistive load, maximum current limit/compliance).

GUARD OFFSET VOLTAGE: <4mV (current ≤10mA).

CURRENT PROGRAMMING ACCURACY⁶

RANGE	PROGRAMMING RESOLUTION	ACCURACY (1 Year) 23°C ±5°C ±(% rdg. + amps)	NOISE (peak-peak) 0.1Hz–10Hz
100.000 nA	2 pA	0.06% + 100 pA	5 pA
1.00000 μA	20 pA	0.03% + 800 pA	25 pA
10.0000 μA	200 pA	0.03% + 5 nA	60 pA
100.000 μA	2 nA	0.03% + 60 nA	3 nA
1.00000 mA	20 nA	0.03% + 300 nA	6 nA
10.0000 mA	200 nA	0.03% + 6 μA	200 nA
100.000 mA	2 μA	0.03% + 30 μA	600 nA
1.00000 A ²	20 μA	0.05% + 1.8 mA	70 μA
1.50000 A ²	50 μA	0.06% + 4 mA	150 μA
10.0000 A ^{2,5}	200 μA	0.5% + 40 mA	

TEMPERATURE COEFFICIENT (0°–18°C & 28°–50°C): ±(0.15 × accuracy specification)°C.

MAXIMUM OUTPUT POWER AND SOURCE/SINK LIMITS²: 30.603W per channel maximum.
±1.515A @ ±20.2V, ±101mA @ ±202V, four quadrant source or sink operation.

CURRENT REGULATION: Line: 0.01% of range. Load: ±(0.01% of range + 100pA).

VOLTAGE LIMIT/COMPLIANCE⁴: Bipolar voltage limit (compliance) set with a single value.
Minimum value is 10mV Accuracy same as voltage source.

OVERSHOOT: <0.1% typical (step size = 10% to 90% of range, resistive load; see CURRENT SOURCE OUTPUT SETTLING TIME for additional test conditions).

ADDITIONAL SOURCE SPECIFICATIONS

TRANSIENT RESPONSE TIME: <70μs for the output to recover to 0.1% for a 10% to 90% step change in load.

VOLTAGE SOURCE OUTPUT SETTLING TIME: Time required to reach 0.1% of final value after source level command is processed on a fixed range.

200mV, 2V Ranges: <50μs typical. 20V Range: <100μs typical. 200V Range: <700μs typical.

CURRENT SOURCE OUTPUT SETTLING TIME: Time required to reach 0.1% of final value after source level command is processed on a fixed range. Values below for Iout · Rload = 2V unless noted.

1.5A–1A Ranges: <120μs typical (Rload >6Ω). 10μA Range: <500μs typical.

100mA–10mA Ranges: <80μs typical. 1μA Range: <2ms typical.

1mA Range: <100μs typical. 100nA Range: <20ms typical.

100μA Range: <150μs typical.

DC FLOATING VOLTAGE: Output can be floated up to ±250VDC from chassis ground.

REMOTE SENSE OPERATING RANGE⁵: Maximum voltage between HI and SENSE HI = 3V.
Maximum voltage between LO and SENSE LO = 3V.

VOLTAGE OUTPUT HEADROOM:

200V Range: Max. output voltage = 202.3V – total voltage drop across source leads (maximum 1Ω per source lead).

20V Range: Max. output voltage = 23.3V – total voltage drop across source leads (maximum 1Ω per source lead).

OVER TEMPERATURE PROTECTION: Internally sensed temperature overload puts unit in standby mode.

VOLTAGE SOURCE RANGE CHANGE OVERSHOOT: Overshoot into a 100kΩ load, 20MHz BW, 300mV typical.

CURRENT SOURCE RANGE CHANGE OVERSHOOT: <5% + 300mV/Rload + 60nA of larger range typical. (See CURRENT SOURCE OUTPUT SETTLING TIME for additional test conditions.)

PULSE SPECIFICATIONS

REGION	MAXIMUM CURRENT LIMIT	MAXIMUM PULSE WIDTH ⁸	MAXIMUM DUTY CYCLE ⁹
1	100 mA @ 200 V	DC, no limit	100%
1	1.5 A @ 20 V	DC, no limit	100%
2	1 A @ 180 V	8.5 ms	1%
3 ¹⁰	1 A @ 200 V	2.2 ms	1%
4	10 A @ 5 V	1 ms	2.2%

MINIMUM PROGRAMMABLE PULSE WIDTH⁸: 200μs. NOTE: Minimum pulse width for settled source at a given I/V output and load can be longer than 200μs. See note 11 for typical settling times.

PULSE WIDTH PROGRAMMING RESOLUTION: 1μs.

PULSE WIDTH PROGRAMMING ACCURACY⁸: ±25μs.

TYPICAL PULSE WIDTH JITTER: 50μs.

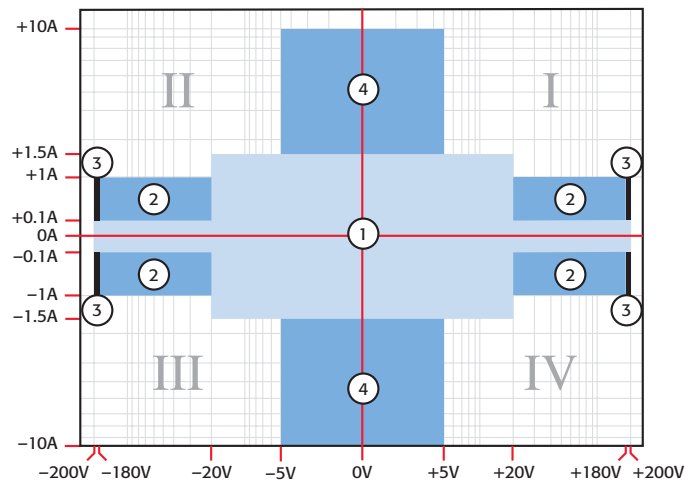

1.888.KEITHLEY (U.S. only)

www.keithley.com

KEITHLEY

A GREATER MEASURE OF CONFIDENCE

2611 2612

System SourceMeter® Multi-Channel I-V Test Solutions

SOURCE SPECIFICATIONS (continued)

PULSE SPECIFICATIONS (continued)

NOTES

1. Add 50µV to source accuracy specifications per volt of HI lead drop.
2. Full power source operation regardless of load to 30°C ambient. Above 30°C and/or power sink operation, refer to Section 8 – Operating Boundaries in the Series 2600 Reference Manual for additional power derating information.
3. For sink mode operation (quadrants II and IV), add 12% of limit range and ±0.02% of limit setting to corresponding current limit accuracy specifications. For 1A range add an additional 40mA of uncertainty.
4. For sink mode operation (quadrants II and IV), add 10% of compliance range and ±0.02% of limit setting to corresponding voltage source specification. For 200mV range add an additional 120mV of uncertainty.
5. 10A range accessible only in pulse mode.
6. Accuracy specifications do not include connector leakage. Derate accuracy by $V_{out}/2E11$ per °C when operating between 18°–28°C. Derate accuracy by $V_{out}/2E11 + (0.15 * V_{out}/2E11)$ per °C when operating <18°C and >28°C.
7. 150mV under pulse conditions with compliance set to 1A.
8. Times measured from the start of pulse to the start of off-time; see figure below.

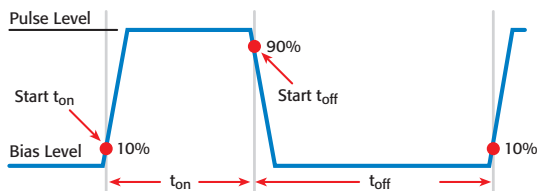

9. Thermally limited in sink mode (quadrants 2 and 4) and ambient temperatures above 30°C. See power equations in the reference manual for more information.
10. Voltage source operation with 1.5A current limit.
11. Typical performance for minimum settled pulse widths:

Source Value	Load	Source Settling (% of range)	Min. Pulse Width
5 V	0.5 Ω	1%	300 µs
20 V	200 Ω	0.2%	200 µs
180 V	180 Ω	0.2%	5 ms
200V (1.5A limit)	200 Ω	0.2%	1.5 ms
100 mA	200 Ω	1%	200 µs
1 A	20 Ω	1%	500 µs
1 A	180 Ω	0.2%	5 ms
10 A	0.5 Ω	0.5%	300 µs

Typical tests were performed using remote operation, 4W sense, Keithley 2600-BAN cables and best, fixed measurement range. For more information on pulse scripts, see the Series 2600 Reference Manual.

METER SPECIFICATIONS

VOLTAGE MEASUREMENT ACCURACY^{1,7}

RANGE	DISPLAY RESOLUTION ³	INPUT RESISTANCE	ACCURACY (1 Year) 23°C ±5°C ±(% rdg. + volts)
200.000 mV	1 µV	>10 GΩ	0.015% + 225 µV
2.00000 V	10 µV	>10 GΩ	0.02 % + 350 µV
20.0000 V	100 µV	>10 GΩ	0.015% + 5 mV
200.000 V	1 mV	>10 GΩ	0.015% + 50 mV

TEMPERATURE COEFFICIENT (0°–18°C & 28°–50°C): ±(0.15 × accuracy specification)/°C.

CURRENT MEASUREMENT ACCURACY^{6,7}

RANGE	DISPLAY RESOLUTION ³	VOLTAGE BURDEN ²	ACCURACY (1 Year) 23°C ±5°C ±(% rdg. + amps)
100.000 nA	1 pA	<1 mV	0.05 % + 100 pA
1.00000 µA	10 pA	<1 mV	0.025% + 500 pA
10.0000 µA	100 pA	<1 mV	0.025% + 1.5 nA
100.000 µA	1 nA	<1 mV	0.02 % + 25 nA
1.00000 mA	10 nA	<1 mV	0.02 % + 200 nA
10.0000 mA	100 nA	<1 mV	0.02 % + 2.5 µA
100.000 mA	1 µA	<1 mV	0.02 % + 20 µA
1.00000 A	10 µA	<1 mV	0.03 % + 1.5 mA
1.50000 A	10 µA	<1 mV	0.05 % + 3.5 mA
10.0000 A ⁵	100 µA	<1 mV	0.4 % + 25 mA

TEMPERATURE COEFFICIENT (0°–18°C & 28°–50°C): ±(0.15 × accuracy specification)/°C.

CONTACT CHECK⁴

SPEED	MAXIMUM MEASUREMENT TIME TO MEMORY FOR 60Hz (50Hz) ⁴	ACCURACY (1 Year) 23°C ±5°C ±(%rdg. + ohms)
FAST	1 (1.2) ms	5% + 10
MEDIUM	4 (5) ms	5% + 1
SLOW	36 (42) ms	5% + 0.3

ADDITIONAL METER SPECIFICATIONS

LOAD IMPEDANCE: Stable into 10,000pF typical.

COMMON MODE VOLTAGE: 250VDC.

COMMON MODE ISOLATION: >1GΩ, <4500pF.

OVERRANGE: 101% of source range, 102% of measure range.

MAXIMUM SENSE LEAD RESISTANCE: 1kΩ for rated accuracy.

SENSE INPUT IMPEDANCE: >10GΩ.

NOTES

1. Add 50µV to source accuracy specifications per volt of HI lead drop.
2. Four-wire remote sense only.
3. Applies when in single channel display mode.
4. Includes measurement of SENSE HI to HI and SENSE LO to LO contact resistances.
5. 10A range accessible only in pulse mode.
6. De-rate accuracy by $V_{out}/2E11$ per °C when operating between 18°–28°C. Derate accuracy by $V_{out}/2E11 + (0.15 * V_{out}/2E11)$ per °C when operating <18°C and >28°C.
7. De-rate accuracy specifications for NPLC setting <1 by increasing error term. Add appropriate % of range term using table below:

NPLC Setting	200mV Range	2V–200V Ranges	100nA Range	1µA–100mA Ranges	1A–1.5A Ranges
0.1	0.01%	0.01%	0.01%	0.01%	0.01%
0.01	0.08%	0.07%	0.1 %	0.05%	0.05%
0.001	0.8 %	0.6 %	1 %	0.5 %	1.1 %

1.888.KEITHLEY (U.S. only)

www.keithley.com

KEITHLEY

A GREATER MEASURE OF CONFIDENCE

2611
2612

System SourceMeter® Multi-Channel I-V Test Solutions

Series 2600 specifications

SOURCE AND MEASURE

GENERAL

HOST INTERFACES: Computer control interfaces.

IEEE-488: IEEE-488.1 compliant. Supports IEEE-488.2 common commands and status model topology.

RS-232: Baud rates from 300 bps to 115200 bps. Programmable number of data bits, parity type, and flow control (RTS/CTS hardware or none). When not programmed as the active host interface, the SourceMeter can use the RS-232 interface to control other instrumentation.

EXPANSION INTERFACE: The TSP-Link expansion interface allows TSP enabled instruments to trigger and communicate with each other.

Cable Type: Category 5e or higher LAN crossover cable.

Length: 3 meters maximum between each TSP enabled instrument.

DIGITAL I/O INTERFACE (see 2601/02 GENERAL specifications for circuit diagram):

Connector: 25-pin female D.

Input/Output Pins: 14 open drain I/O bits.

Absolute Maximum Input Voltage: 5.25V

Absolute Minimum Input Voltage: -0.25V

Maximum Logic Low Input Voltage: 0.7V +850 μ A max.

Minimum Logic High Input Voltage: 2.1V +570 μ A.

Maximum Source Current (flowing out of Digital I/O bit): +960 μ A.

Maximum Sink Current @ Maximum Logic Low Voltage (0.7V): -5.0mA.

Absolute Maximum Sink Current (flowing into Digital I/O pin): -11mA.

5V Power Supply Pin: Limited to 600mA, solid state fuse protected.

Safety Interlock Pin: Active high input. >3.4V @ 24mA (absolute maximum of 6V) must be externally applied to this pin to insure 200V operation. This signal is pulled down to chassis ground with a 10k Ω resistor. 200V operation will be blocked when the INTERLOCK signal is <0.4V (absolute minimum of -0.4V). See figure below:

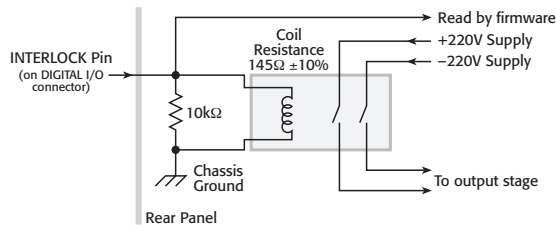

POWER SUPPLY: 100V to 240VAC, 50–60Hz (manual setting), 240VA max.

COOLING: Forced air. Side intake and rear exhaust. One side must be unobstructed when rack mounted.

WARRANTY: 1 year.

EMC: Conforms to European Union Directive 89/336/EEC, EN 61326-1.

SAFETY: Conforms to European Union Directive 73/23/EEC, EN 61010-1, and UL 61010-1.

DIMENSIONS: 89mm high \times 213mm wide \times 460mm deep (3½ in \times 8½ in \times 17½ in). Bench Configuration (with handle & feet): 104mm high \times 238mm wide \times 460mm deep (4½ in \times 9½ in \times 17½ in).

WEIGHT: 2611: 4.75kg (10.4 lbs). 2612: 5.50kg (12.0 lbs).

ENVIRONMENT: For indoor use only.

Altitude: Maximum 2000 meters above sea level.

Operating: 0°–50°C, 70% R.H. up to 35°C. Derate 3% R.H./°C, 35°–50°C.

Storage: -25°C to 65°C.

1.888.KEITHLEY (U.S. only)

www.keithley.com

KEITHLEY

A GREATER MEASURE OF CONFIDENCE

Series 2600

System SourceMeter® Multi-Channel I-V Test Solutions

SPEED SPECIFICATIONS ¹

MAXIMUM SWEEP OPERATION RATES (operations per second) FOR 60Hz (50Hz):

A/D CONVERTER SPEED	TRIGGER ORIGIN	MEASURE TO MEMORY	MEASURE TO GPIB	SOURCE MEASURE TO MEMORY	SOURCE MEASURE TO GPIB	SOURCE MEASURE PASS/FAIL TO MEMORY	SOURCE MEASURE PASS/FAIL TO GPIB
0.001 NPLC	Internal	10000 (10000)	8000 (8000)	5500 (5500)	3600 (3600)	4900 (4900)	3100 (3100)
0.001 NPLC	Digital I/O	2700 (2650)	2100 (2100)	2300 (2300)	1900 (1875)	2200 (2150)	1800 (1775)
0.01 NPLC	Internal	4000 (3500)	3600 (3200)	2750 (2700)	2300 (2100)	2800 (2500)	2100 (1975)
0.01 NPLC	Digital I/O	1900 (1775)	1600 (1500)	1700 (1600)	1450 (1400)	1600 (1500)	1400 (1325)
0.1 NPLC	Internal	565 (475)	555 (470)	540 (450)	510 (440)	535 (455)	505 (430)
0.1 NPLC	Digital I/O	490 (420)	470 (405)	470 (410)	450 (390)	470 (400)	450 (390)
1.0 NPLC	Internal	59 (49)	59 (49)	58 (49)	58 (48)	58 (49)	58 (48)
1.0 NPLC	Digital I/O	58 (48)	58 (48)	58 (48)	57 (48)	57 (48)	57 (48)

MAXIMUM SINGLE MEASUREMENT RATES (operations per second) FOR 60Hz (50Hz):

A/D CONVERTER SPEED	TRIGGER ORIGIN	MEASURE TO GPIB	SOURCE MEASURE TO GPIB	SOURCE MEASURE PASS/FAIL TO GPIB
0.001 NPLC	Internal	1110 (1000)	880 (880)	840 (840)
0.01 NPLC	Internal	950 (900)	780 (760)	730 (710)
0.1 NPLC	Internal	390 (345)	355 (320)	340 (305)
1.0 NPLC	Internal	57 (48)	56 (47)	56 (47)

MAXIMUM MEASUREMENT RANGE CHANGE RATE: >4500/second typical. When changing to or from a range $\geq 1A$, maximum rate is >2000/second typical.

MAXIMUM SOURCE RANGE CHANGE RATE: >400/second, typical.

MAXIMUM SOURCE FUNCTION CHANGE RATE: >500/second, typical.

EXTERNAL TRIGGER INPUT: The Digital I/O interface signals can be configured to behave as trigger inputs.

Input Latency (time from trigger input to start of measurement or source change): <150 μ s, typical.

Input Jitter: <100 μ s, typical.

COMMAND PROCESSING TIME: Maximum time required for the output to begin to change following the receipt of the smux.source.level or smux.source.level1 command. <1ms typical.

NOTES

1. See the Speed Specifications Test Conditions Appendix in the Series 2600 Reference Manual for more information regarding test conditions.

Specifications are subject to change without notice. Rev. B



Model 2601/2611 Rear Panel

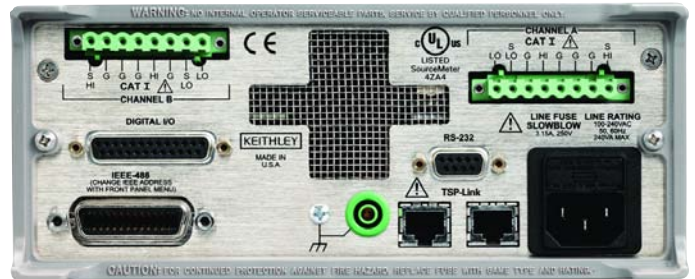

Model 2602/2612 Rear Panel

Series 2600 specifications

SOURCE AND MEASURE

1.888.KEITHLEY (U.S. only)

www.keithley.com

KEITHLEY

A GREATER MEASURE OF CONFIDENCE

Series 2600

System SourceMeter[®] Multi-Channel I-V Test Solutions

SUPPLEMENTAL INFORMATION

FRONT PANEL INTERFACE: 2-line vacuum fluorescent display (VFD) with keypad and rotary knob.

Display:

- Show error messages and user defined messages
- Display source and limit settings
- Show current and voltage measurements
- View measurements stored in non-volatile reading buffers

Keypad Operations:

- Change host interface settings
- Save and restore instrument setups
- Load and run factory and user defined test scripts (i.e. sequences) that prompt for input and send results to the display
- Store measurements into non-volatile reading buffers

PROGRAMMING: Embedded Test Script Processor (TSP) accessible from any host interface. Responds to individual instrument control commands. Responds to high speed test scripts comprised of instrument control commands and Test Script Language (TSL) statements (e.g. branching, looping, math, etc.). Able to execute high speed test scripts stored in memory without host intervention.

Minimum Memory Available: 3 Mbytes (approximately 50,000 lines of TSL code).

Test Script Builder: Integrated Development Environment for building, running, and managing TSP scripts. Includes an Instrument Console for communicating with any TSP enabled instrument in an interactive manner. Requires:

- VISA (NI-VISA included on CD)
- Microsoft .NET Framework (included on CD)
- Keithley I/O Layer (included on CD)
- Pentium III 800MHz or faster personal computer
- Microsoft Windows 98, NT, 2000, or XP

Drivers:IVI/VISA drivers for VB, VC/C++, LabVIEW, TestPoint, and LabWindows/CVI

READING BUFFERS: Non-volatile storage area(s) reserved for measurement data. Reading buffers are arrays of measurement elements. Each element can hold the following items:

- Measurement
- Measurement status
- Timestamp
- Source setting (at the time the measurement was taken)
- Range information

Two reading buffers are reserved for each SourceMeter channel. Reading buffers can be filled using the front panel STORE key and retrieved using the RECALL key or host interface.

Buffer Size, with timestamp and source setting: >50,000 samples.

Buffer Size, without timestamp and source setting: >100,000 samples.

Battery Backup: Lithium-ion battery backup. 30 days of non-volatile storage @ 23°C, and >4 hours of charge time. 3 year battery life @ 23°C. 1.5 year battery life @ 50°C.

FACTORY TSP SCRIPTS: See www.keithley.com for Keithley-supported application-specific scripts.

SYSTEM EXPANSION: The TSP-Link expansion interface allows TSP enabled instruments to trigger and communicate with each other. See figure below:

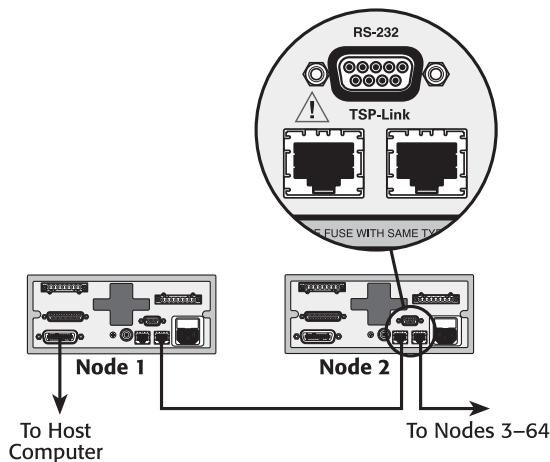

Each SourceMeter has two TSP-Link connectors to facilitate chaining instruments together.

- Once SourceMeter instruments are interconnected via TSP-Link, a computer can access all of the resources of each SourceMeter via the host interface of any SourceMeter.
- A maximum of 64 TSP-Link nodes can be interconnected. Each SourceMeter consumes one TSP-Link node.

TIMER: Free running 47 bit counter with 1MHz clock input. Reset each time instrument powers up. Rolls over every 4 years.

Timestamp: TIMER value automatically saved when each measurement is triggered.

Resolution: 1 μ s.

Accuracy: 50ppm.

Specifications are subject to change without notice.

All Keithley trademarks and trade names are the property of Keithley Instruments, Inc.
All other trademarks and trade names are the property of their respective companies.

KEITHLEY

A G R E A T E R M E A S U R E O F C O N F I D E N C E

KEITHLEY INSTRUMENTS, INC. ■ 28775 AURORA ROAD ■ CLEVELAND, OHIO 44139-1891 ■ 440-248-0400 ■ Fax: 440-248-6168 ■ 1-888-KEITHLEY ■ www.keithley.com

BELGIUM

Sint-Pieters-Leeuw
Ph: 32-2363-0040
Fax: 32-2363-0064
www.keithley.nl

CHINA

Beijing
Ph: 8610-82255010
Fax: 8610-82255018
www.keithley.com.cn

FINLAND

Espoo
Ph: 358 9 88171661
Fax: 358 9 88171662
www.keithley.com

FRANCE

Saint-Aubin
Ph: 33-1-6453-2020
Fax: 33-1-60-1-77-26
www.keithley.fr

GERMANY

Germering
Ph: 49-89-84-93-070
Fax: 49-89-84-93-0734
www.keithley.de

UNITED KINGDOM

Theale
Ph: 44-118-929-7500
Fax: 44-118-929-7519
www.keithley.co.uk

INDIA

Bangalore
Ph: 91-80-2212-8027
Fax: 91-80-2212-8005
www.keithley.com

ITALY

Milano
Ph: 39-02-553-8421
Fax: 39-02-55 38 42 28
www.keithley.it

JAPAN

Tokyo
Ph: 81-3-5733-7555
Fax: 81-3-5733-7556
www.keithley.jp

KOREA

Seoul
Ph: 82-2-574-7778
Fax: 82-2-574-7838
www.keithley.co.kr

MALAYSIA

Kuala Lumpur
Ph: 60-3-4041-0899
Fax: 60-3-4042-0899
www.keithley.com

NETHERLANDS

Gorinchem
Ph: 31-1-836-35333
Fax: 31-1-836-30821
www.keithley.nl

SINGAPORE

Singapore
Ph: 65-6747-9077
Fax: 65-6747-2991
www.keithley.com.sg

SWEDEN

Solna
Ph: 46-8-509-04-600
Fax: 46-8-655-26-10
www.keithley.com

TAIWAN

Hsinchu
Ph: 886-3-572-9077
Fax: 886-3-572-9031
www.keithley.com.tw