

DECTRIS

Next Generation X-Ray Detectors

USER MANUAL

PILATUS 100K Detector System



Version 1.0

Table of Contents

1	Document History	4
1.1	Changes	4
2	How to use this manual	5
2.1	Address and support.....	5
2.2	Explanation of symbols.....	5
2.3	Explanation of terms	6
3	Technical specifications	7
3.1	Technical data	7
3.2	Normal operation	7
3.3	Input voltages	7
3.4	Ambient conditions	8
3.5	Mounting the detector system.....	8
3.6	Front side of the detector.....	9
3.7	Backside of the detector	10
4	Certification tests	11
5	Warnings.....	12
6	System Description.....	13
6.1	Overview.....	13
6.2	Principle.....	13
6.3	Software	15
6.3.1	Overview of TVX.....	16
6.3.2	Overview of Camserver	17
6.4	Integration into other systems.....	18
7	Getting started	19
7.1	Mounting the detector	19
7.2	Connect to nitrogen	19
7.3	Connect the cables	19
7.4	Connect the power supply	20
8	How to operate the system	21
8.1	Login to the computer	21
8.2	Connect to a network.....	21
8.3	Start.....	21
9	Description of the directories	24
10	How to use TVX	25
10.1	Main commands	25
	Description of the image display.....	28
10.2	Image formats.....	32
10.3	Analysis commands.....	32
10.4	User defined commands.....	34
11	How to use Camserver.....	35
11.1	Main commands	35
11.2	Variables.....	36
12	Special procedures	37
12.1	Exposures series	37
12.2	Adjusting the threshold level.....	38
12.3	Adjusting the analog amplifier.....	39

13	Calibrating the detector	40
13.1	Principle.....	40
13.2	Creating a trim file.....	41
13.3	Loading trim files	44
13.4	Mask files.....	44
13.5	Setting a trimmed threshold.....	45
13.6	Creating a flat field correction image	46
13.7	Using the flat field correction image.....	47
14	External Triggering	48
14.1	Command list.....	48
14.2	External Trigger mode	49
14.3	External Enable mode	50
14.4	Multiple Exposure mode	52
15	Maintenance.....	53
16	Troubleshooting	54
17	Appendix	55
17.1	Table of figures.....	55

1 Document History

Actual document

Version	Date	status	prepared	checked	released
1.0	19.02.2007	Released	PS	CB	PS

1.1 Changes

Version	Date	Changes

2 How to use this manual

Before you start to operate the PILATUS 100K detector system please read this manual thoroughly.

This user manual has been especially designed for the DECTRIS PILATUS 100K detector system.





2.1 Address and support

DECTRIS Ltd.
5232 Villigen PSI
Switzerland
Phone: +41 56 310 54 52
Fax: + 41 56 310 54 54

Email: support@dectris.com

Should you have questions concerning the system or its use, please contact us via phone, mail or fax.

2.2 Explanation of symbols

Symbol	Description
	Important or helpful notice
	Caution. Please follow the instruction carefully to prevent equipment damage or personal injury.
	DC-current
	AC-current
	Ground

2.3 Explanation of terms

Term	Description
MCB	Module control board
DCB	Detector control board
DAC	Digital to Analog Converter

3 Technical specifications

3.1 Technical data



Pixel size	172 x 172 μm^2
Format	487 x 195 = 94 965 pixels
Active area	83.8 x 33.5 mm^2
Counting rate	> 2×10^6 counts/s/pixel
Energy range	3 – 30 keV
Readout time	< 2.7 ms
Framing rate	> 200 Hz
Power consumption	5W, air cooled
Dimensions	285 x 146 x 85 mm^3
Weight	3.9 kg

3.2 Normal operation

The PILATUS 100K detector system has been designed for the detection of X-rays from synchrotrons or laboratory sources.

For other applications, please contact DECTRIS for additional information.

3.3 Input voltages

Device	Definition
Power supply	Input range specified on the back of the power supply.  Connecting to the wrong supply voltage will destroy the power supply and could damage the detector.
PC	The PC runs on 100V-240 VAC, 50/60Hz and can be connected to all common supply voltages.
Detector External Trigger Input	3.3 V TTL; 5.0 V absolute maximum  Applying a higher voltage will destroy the input
Detector Enable output	3.3 V TTL

3.4 Ambient conditions

The PILATUS 100K detector is designed only for indoor use according the following ambient conditions.

Condition	Range
Operating temperature:	20 to 35° C
Operating humidity:	<70% at 20° C
Storage temperature	15 to 40 C
Storage humidity	< 75% at 20° C



If the detector system is stored in low temperature, make sure that no condensation moisture develops.

3.5 Mounting the detector system

The power supply and PC are can be mounted in a standard 19 inch rack, which should be properly grounded.



Make sure that the power supply and the PC have adequate ventilation.

The detector can be mounted in any position using the holes in the ground plate.



Make sure the detector has enough space for a proper ventilation. The ventilator on the top of the detector and the ventilation holes on the side of the detector should not be covered. Do not use in vacuum.



Although the detector might be grounded via the mounting bolts, the detector must be grounded via the ground connector on the back to establish a defined grounding.

Note: The APS Detector Pool's module (159) has a slightly different housing!!!!!!

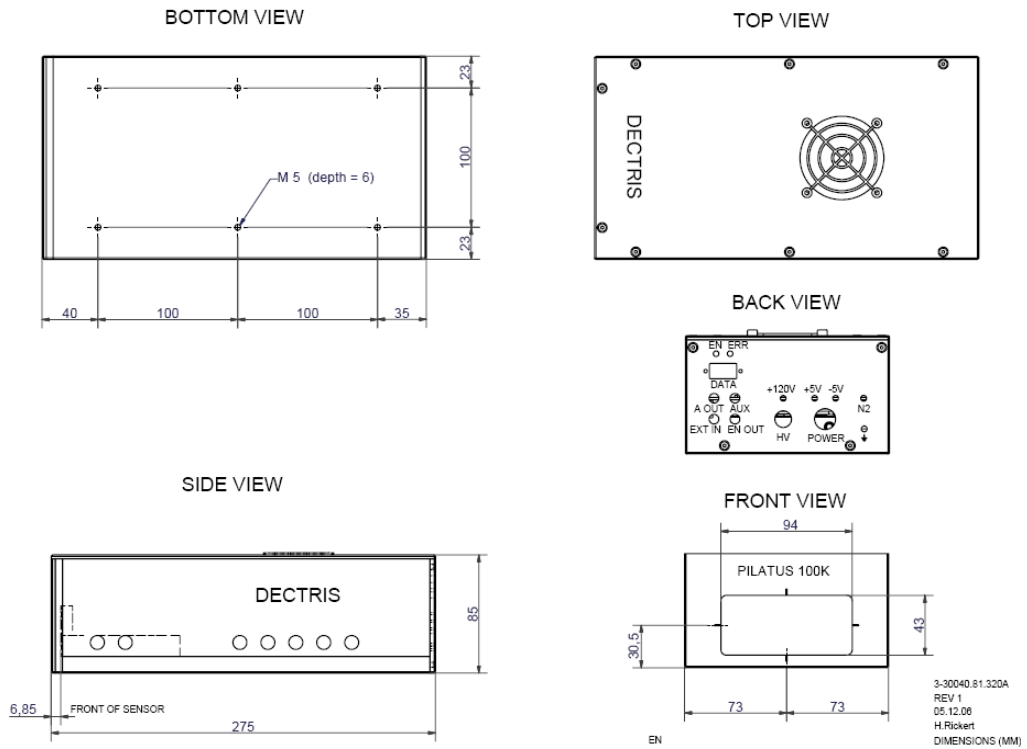

Figure 1. Drawing of the PILATUS 100K detector

3.6 Front side of the detector

The detector comes with a protective aluminum cover for the front window and the sensor that should be removed for operation. The sensor is behind a 50 um thick aluminized mylar foil to protect it from dust and touch.



Do not touch the mylar foil





Figure 2. PILATUS 100K detector with aluminum cover in place (left) and removed.

3.7 Backside of the detector



Figure 3. PILATUS 100K detector viewed from the back

Connector	Description
DATA	Data connection
POWER	+/-5 V DC power connection
HV	High voltage 120 V DC bias voltage
A OUT	Analog out (currently unused)
AUX	Auxiliary output (currently unused).
EXT IN	External Trigger Input (TTL, lemo connector)
	 The input voltage should not exceed 5V
EN OUT	TTL output signal; high when counting is enabled.
Ground	Grounding of the detector.
	 Although the detector may be grounded via the mounting bolts, the detector must be grounded via this connector to establish a defined grounding.

LED	Description
+5 V	+5V voltage on
-5 V	-5V voltage on
+120 V	+120V voltage on
EN	Detector is making an exposure
ERR	Data connection to the PC failed

4 Certification tests

The following tests have been completed:

§	Test Type / Type d'essai / Art der Prüfung	
	Emission / Emission / Störaussendung	<i>EN 61326</i>
	Interference voltage EN 55022:1998 + A1 + A2 CISPR 22 Cl A/B: 2005 + A1	OK
	Radiated electromagnetic field EN 55022:1998 + A1 + A2 CISPR 22: 2005 + A1	OK
	Immunity / Immunité / Störfestigkeit	<i>EN 61326</i>
	Electrostatic discharges EN 61000-4-2:1995 + A1 + A2 IEC 61000-4-2:1995 + A1 + A2	Criterion C
	Electromagnetic fields EN 61000-4-3:2002 + A1 IEC 61000-4-3:2002 + A1	Criterion A at 10 V/m
	Fast electric transients (Burst) EN 61000-4-4:2004 IEC 61000-4-4:2004	Criterion A
	Surges EN 61000-4-5:1995 + A1 IEC 61000-4-5:1995 + A1	Criterion A
	Radio frequency common mode EN 61000-4-6:1996 + A1 IEC 61000-4-6:1996 + A1	Criterion A
	Voltage dips and interruptions EN 61000-4-11:2004 IEC 61000-4-11:2004	Criterion A

5 Warnings



Please read these warnings before operating the detector

- Before turning the power supply on, check the supply voltage with the label on the power supply. Using the improper mains voltage will destroy the power supply and damage the detector.
- Power down the detector system before connecting or disconnecting any cable.
- Make sure the cables are connected and properly secured.
- Avoid pressure or tension on the cables.
- The air intakes and outlet for the detector fan should not be obstructed.
- The detector system should have enough space for proper ventilation. Operating the detector outside the specified ambient conditions could damage the system
- The power supply should have at least 1 cm of space underneath, to provide proper ventilation. Do not cover the power supply.
- Do not touch the entrance window of the detector.
- The detector is not specified to withstand direct beam at a synchrotron. Such exposure will damage the exposed pixels.
- Replace the protective cover when the detector is not in use.
- On powering up the detector, the ammeter on the power supply should show a current of approximately 2 A. In operation the ammeter should not exceed a current of about 2.8 A.
With any over-current condition, immediately shut the detector down and restart it.
- Opening the detector or the power supply housing will void the warranty.

6 System Description

6.1 Overview

The PILATUS 100K detector system consists of the following components:

- 100K detector
- Analysis PC with SuSE Linux, and the data acquisition and data analysis tool TVX
- Power supply
- Connecting cables

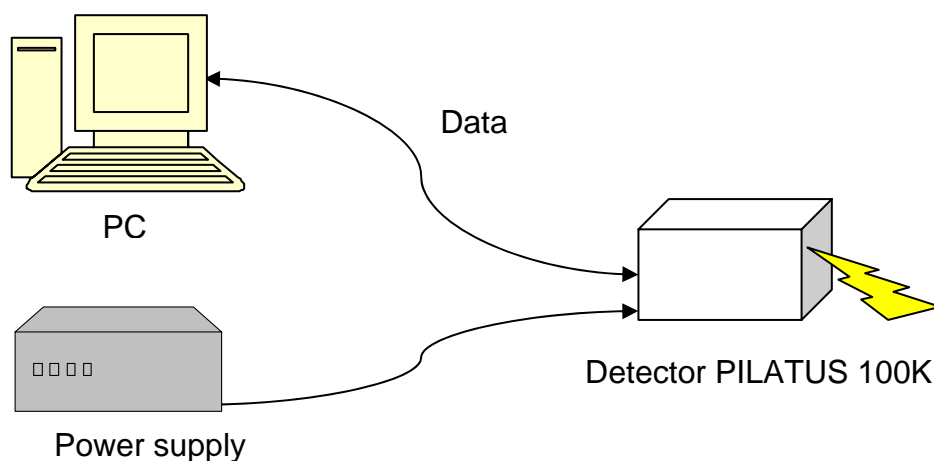

Figure 4. Overview of the PILATUS 100K detector system setup.

6.2 Principle

DECTRIS X-ray detector systems operate in "single photon counting" mode and are based on the newly developed hybrid pixel technology. The main difference with respect to existing detectors is that the x-rays are directly transformed into electric charge (Figure 5) and processed in the CMOS readout chips. This new design has no dark current or readout noise, a high dynamic range of 1'000'000 (20 bits), a read out time of less than 3 ms, a framing rate of over 200 images/s and an excellent point spread function < 1 pixel). The quantum efficiency of the 0.32 mm thick silicon sensor is optimal for experiments in the energy range from 3-12 keV; however the detectors can be used for energies of up to 30keV or more. The counting rate is more than 2×10^6 /s/pixel, enough to perform many experiments using the high flux of modern synchrotron light sources.

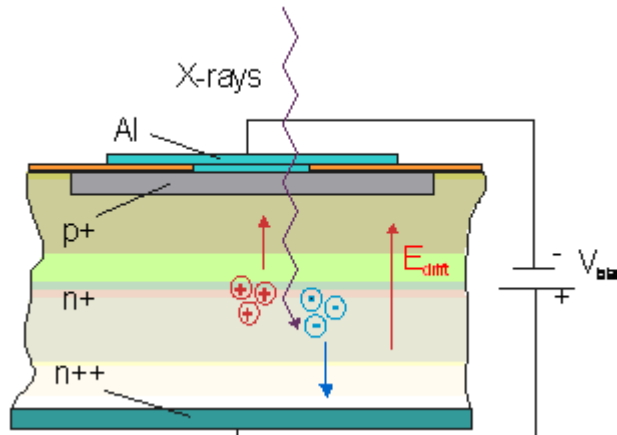

Figure 5. Principle of direct detection. Contrary to what is illustrated, x-rays normally impinge on the lower surface.

A DECTRIS hybrid pixel detector is composed of a silicon sensor, which is a two-dimensional array of pn-diodes processed in high-resistivity silicon, connected to an array of readout channels designed with advanced CMOS technology (Figure 6). Each readout channel is connected to its corresponding detecting element through a microscopic indium ball, with a typical diameter of 18 μm . This connection process is called 'bump-bonding'.

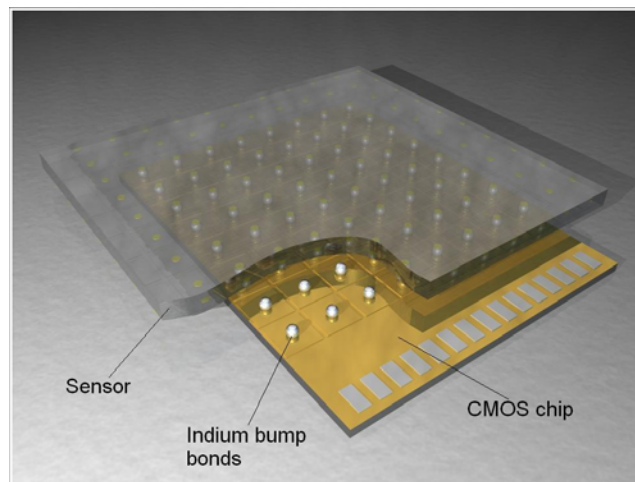

Figure 6. Diagram of a bump bonded hybrid chip.

The great advantage of this approach is that standard technologies are used for both the silicon sensor and the CMOS readout chips, which guarantees highest quality. Both processes are optimized separately, as the best silicon substrates for X-ray detection and for high-speed/high-quality electronics are very different. Moreover, the small size of the pixel and of the interconnection results in a very low capacitance, which has the beneficial effect of reducing the noise and power consumption of the pixel readout electronics.

X-ray data collection can be improved with detectors operating in single photon counting mode. A hybrid pixel which features single photon counting

comprises a preamplifier, which amplifies the charge generated in the sensor by the incoming X-ray, and a discriminator, which produces a digital signal if the incoming charge exceeds a pre-defined threshold. The discriminator feeds a 20 bit counter, which then leads to completely digital storage and noiseless readout of the number of detected X-rays in each pixel.

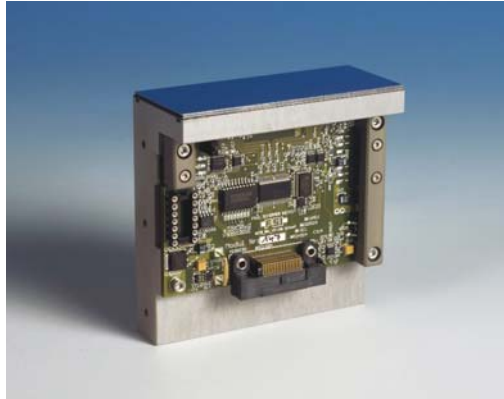

Figure 7. A module, the fundamental unit of every DECTRIS detector.

The fundamental unit of the DECTRIS detectors consists of a single fully depleted monolithic silicon sensor with an 8 x 2 array of CMOS readout chips bump-bonded to it. Each sensor is a continuous array of $487 \times 197 = 94965$ pixels without dead areas and covers an active area of $83.8 \times 33.5 \text{ mm}^2$. The readout chips are wire-bonded to the mounting bracket with its readout control electronics and forms the complete module (Figure 7).

6.3 Software

The operating software for the PILATUS 100K consists of two software components:

- **TVX**
Data acquisition control and data analysis software
- **Camserver**
Operating software for the detector

Those two software packages are normally installed on one PC and communicate with each other through an internal socket connection.

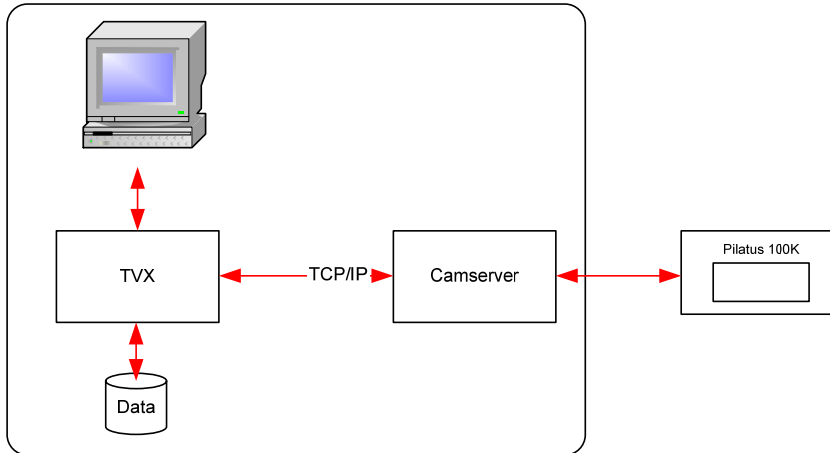

Figure 8. Normal operation with TVX and Camserver on one computer.

But it is also possible, to operate the detector without TVX and access Camserver directly via a socket connection from another PC.

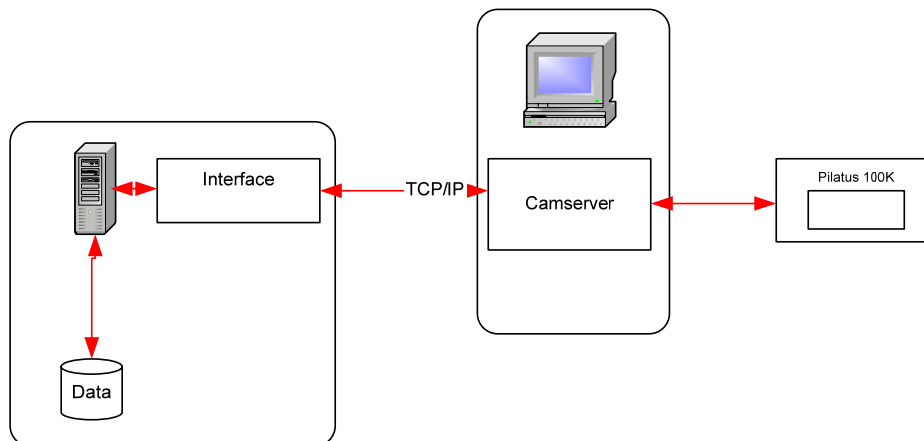

Figure 9. Operation with TVX and Camserver on separate computers.

6.3.1 Overview of TVX

TVX is a free, open source, data acquisition and control software suite tailored to X-ray science. TVX is an attempt to provide a flexible user interface that is easily adapted to control a broad range of 2-D X-ray detectors as well as a powerful collection of analysis tools.

TVX operates by distributing the tasks of data analysis and hardware control between two separate programs. The first program, which is most often referred to as TVX, contains the user interface and analysis tool suite. The other, which is referred to as the Camserver, is responsible for controlling the hardware of the specific data acquisition system. These two programs communicate over a TCP/IP connection, as shown in Figure 8, and thus do not need to run on the same machine, much less under the same operating system; see Figure 9.

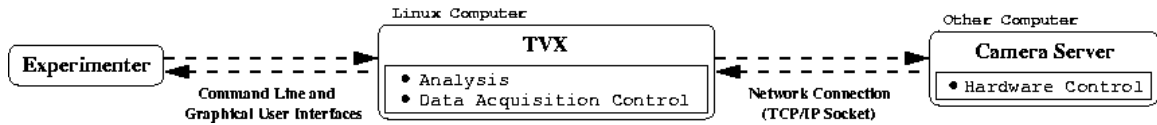

Figure 10: TVX communication scheme

Camserver bundles all of the details of the hardware control into a C program which is easy to port across computer platforms. An added benefit of this model is that it allows the experimenters to do their analysis wherever and whenever it is most convenient from them, be it at the beam line while the data are being taken or back at their home institution or corporation. TVX compiles and operates both on Linux and Mac OS X systems. Camserver, except the demo version, requires specific camera hardware for operation.

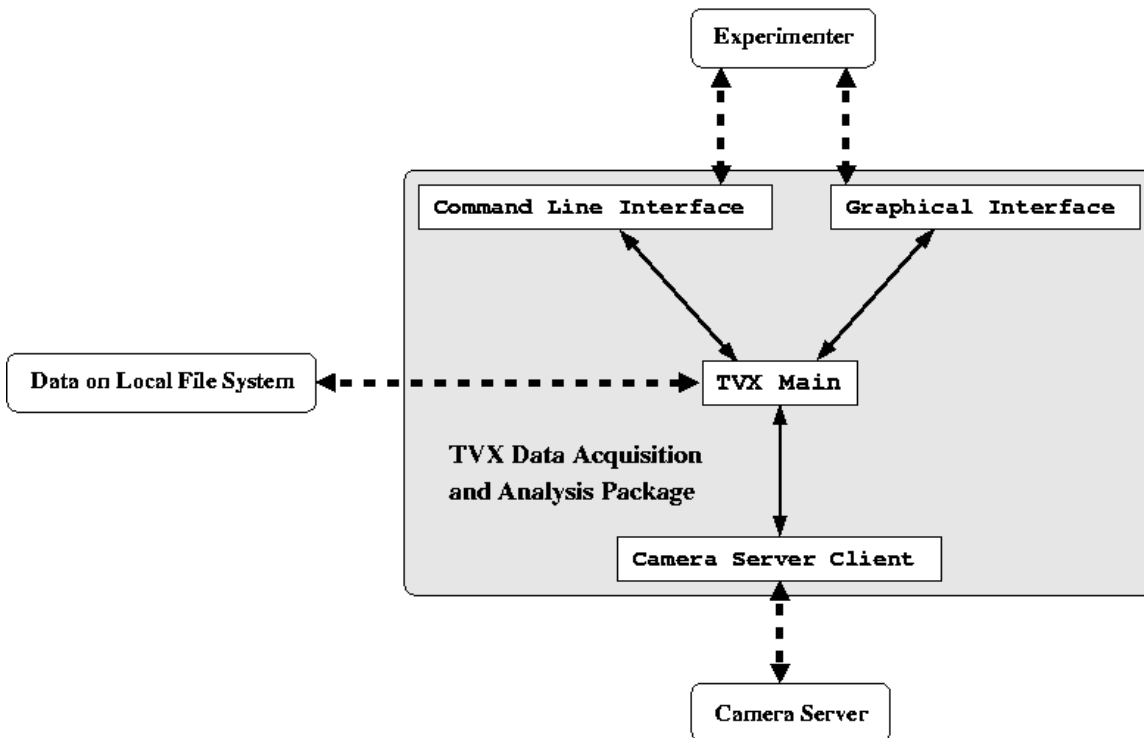

Figure 11. TVX control and analysis layout schematic.

6.3.2 Overview of Camserver

Camserver is a completely freestanding program that controls the detector and provides a simple user interface for "atomic" (single function) commands. It is intended to provide a spartan, but fully functional, low level interface to camera hardware.

On startup, Camserver takes a single command-line argument, the path to its resource file. Camserver will also use the same path to open its debugging file, 'camdbg.out', if that option is enabled.

A major function is to accept socket connections from a high level controller (e.g., TVX), which can provide high level services to this or other cameras.

The interface is a simple text-based message passing system. Images, the ultimate product of a working area x-ray detector, do not pass thru the interface, but are written to a configurable location (e.g., an nfs mount) where either program can access them. Because of the socket connection protocol, the camera hardware and server can reside on a different machine from the high level controller.

Camserver implements a token mechanism (controlling Process) to prevent more than one outside process from having control over the hardware. The Camserver window has full control at all times.

Commands in Camserver that are also present in the TVX main window must have different names to prevent collisions between the enum's in camclient.c and in tvx.c. We distinguish them by upper-casing the last letter (e.g., Run in tvx.c, RuN in Camserver.c), and re-lower the case of the last letter in menu_print to make it look better.

Usually, you don't have to work in the Camserver window. The whole exposure and analyzing process is controlled mainly from the TVX window or via an interface from the beam line control software.

6.4 Integration into other systems

The Camserver program of the PILATUS 100K detector provides a simple to use interface for either EPICS or SPEC. Several clients for these protocols have been written at the Swiss Light Source (SLS) of the Paul Scherrer Institut (PSI). Further information can be provided on request.

7 Getting started

7.1 Mounting the detector

The detector can be mounted in any position. The detector has 6 holes with M5 threads in the baseplate for a stable mount.



Make sure the detector is properly mounted



Make sure the ventilator and the ventilation holes are not covered and have enough space for a proper ventilation.

7.2 Connect to nitrogen

The PILATUS 100K can be connected to a dry nitrogen flow to avoid condensation in humid conditions.



Humidity can damage the detector. Make sure to operate the detector in the specified range.

7.3 Connect the cables

To operate the detector, the 3 power cables and the ground should be connected:

Data cable:

RX to RX and TX to TX on the GigaSTaR Card in the PC; the single connector goes to the back of the detector.



The data cable should be pulled onto the computer connectors with the screws, rather than forcefully pushed on.



It is important for data integrity that the screws be tightened.

High Voltage (120V DC):

Connect the cable to the power supply and the detector

Power supply (+/-5V DC):

Connect the cable to the power supply and the detector. Make sure it is secured properly.

Grounding



Make sure the detector is properly grounded



To plug or unplug any cables turn the power supply and the PC off.

7.4 Connect the power supply



Although the power supply is grounded via the ground connector in the power plug, the housing of the power supply should be properly connected to a grounded rack.

8 How to operate the system

Before you turn on the system, make sure you have read this manual and connected the detector accordingly.

8.1 Login to the computer

Turn on the PC.

Log in procedure:

User:

PW:

Root PW:

8.2 Connect to a network

The IP address of the detector is identical to the IP address of the PC where Camserver is running on. In case TVX and Camserver are running on different machines the IP address and hostname should be adjusted in the following files:

```
/home/det/p2_1mod/tvxrc  
/etc/hosts
```

8.3 Start

- Turn the the power supply on
- The ammeter for the +5V supply voltage on the power supply should show about 2 A.
- Start a shell.
- The default path is: /home/det
- Change the directory to: p2_1mod.
- Type runtvx.
Runtvx starts a script file which initializes the detector system and opens the Camserver and TVX windows.

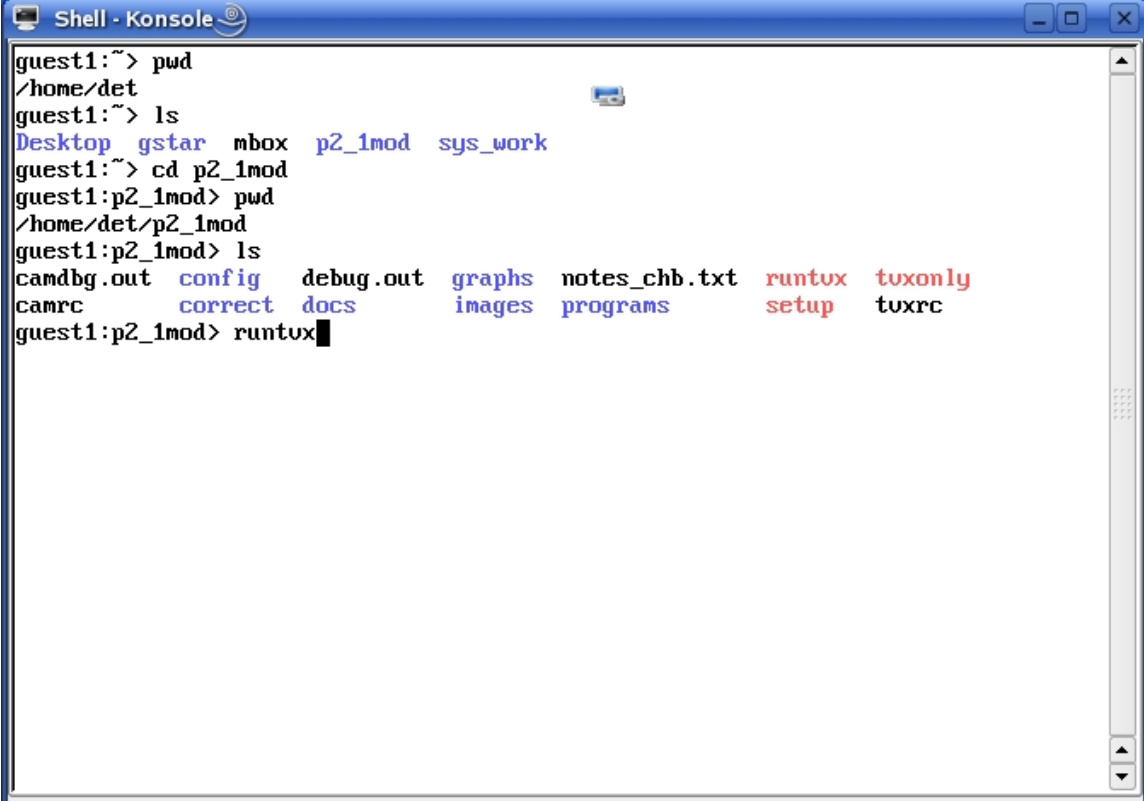

```
Shell - Konsole
guest1:~> pwd
/home/det
guest1:~> ls
Desktop gstar mbox p2_1mod sys_work
guest1:~> cd p2_1mod
guest1:p2_1mod> pwd
/home/det/p2_1mod
guest1:p2_1mod> ls
camdbg.out  config  debug.out  graphs  notes_chb.txt  runtux  tuxonly
camrc       correct docs       images  programs        setup   tuxrc
guest1:p2_1mod> runtux
```

Figure 12. Shell showing the active path and the runtux command.

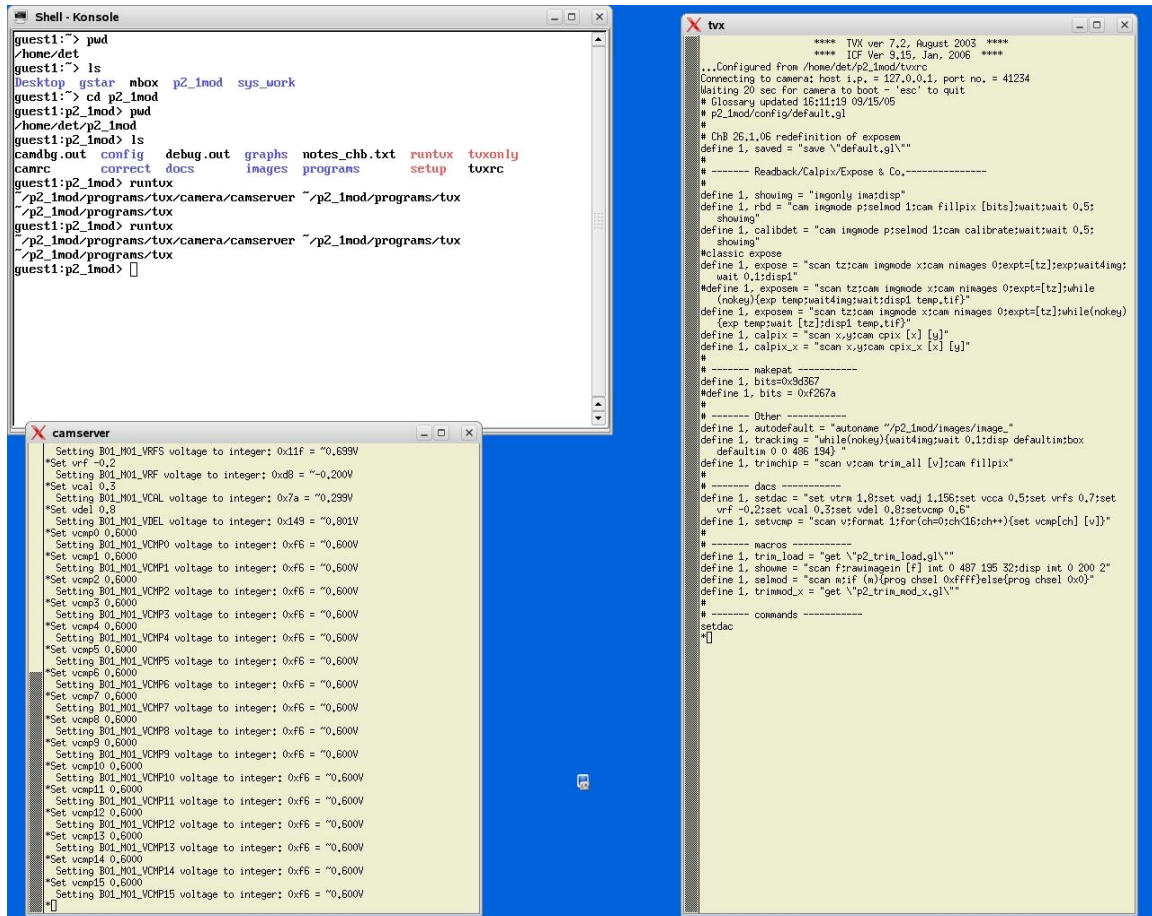

```

Shell - Konsole
-----
guest1:~> pwd
/home/det
guest1:~> ls
Desktop  gstar  mbox  p2_inod  sys_work
guest1:~> cd p2_inod
guest1:p2_inod> pwd
/home/det/p2_inod
guest1:p2_inod> ls
camdb.out  config  debug.out  graphs  notes_chb.txt  runtux  tuxonly
camrc      correct  docs      images  programs       setup  tuxrc
guest1:p2_inod> runtux
~/p2_inod/programs/tux/camera/camsuerver ~/p2_inod/programs/tux
~/p2_inod/programs/tux
guest1:p2_inod> runtux
~/p2_inod/programs/tux/camera/camsuerver ~/p2_inod/programs/tux
~/p2_inod/programs/tux
guest1:p2_inod>

camserver
-----
Setting_B01_M01_VRFS voltage to integer: 0x1f = "0,639V"
*Set vrf -0,2
Setting_B01_M01_VRF voltage to integer: 0xd8 = "-0,200V"
*Set vcal 0,3
Setting_B01_M01_VCAL voltage to integer: 0x7a = "0,289V"
Setting_B01_M01_VIEL voltage to integer: 0x149 = "0,801V"
*Set vcomp0 0,6000
Setting_B01_M01_VCHP0 voltage to integer: 0xf6 = "0,600V"
*Set vcomp1 0,6000
Setting_B01_M01_VCHP1 voltage to integer: 0xf6 = "0,600V"
*Set vcomp2 0,6000
Setting_B01_M01_VCHP2 voltage to integer: 0xf6 = "0,600V"
*Set vcomp3 0,6000
Setting_B01_M01_VCHP3 voltage to integer: 0xf6 = "0,600V"
*Set vcomp4 0,6000
Setting_B01_M01_VCHP4 voltage to integer: 0xf6 = "0,600V"
*Set vcomp5 0,6000
Setting_B01_M01_VCHP5 voltage to integer: 0xf6 = "0,600V"
*Set vcomp6 0,6000
Setting_B01_M01_VCHP6 voltage to integer: 0xf6 = "0,600V"
*Set vcomp7 0,6000
Setting_B01_M01_VCHP7 voltage to integer: 0xf6 = "0,600V"
*Set vcomp8 0,6000
Setting_B01_M01_VCHP8 voltage to integer: 0xf6 = "0,600V"
*Set vcomp9 0,6000
Setting_B01_M01_VCHP9 voltage to integer: 0xf6 = "0,600V"
*Set vcomp10 0,6000
Setting_B01_M01_VCHP10 voltage to integer: 0xf6 = "0,600V"
*Set vcomp11 0,6000
Setting_B01_M01_VCHP11 voltage to integer: 0xf6 = "0,600V"
*Set vcomp12 0,6000
Setting_B01_M01_VCHP12 voltage to integer: 0xf6 = "0,600V"
*Set vcomp13 0,6000
Setting_B01_M01_VCHP13 voltage to integer: 0xf6 = "0,600V"
*Set vcomp14 0,6000
Setting_B01_M01_VCHP14 voltage to integer: 0xf6 = "0,600V"
*Set vcomp15 0,6000
Setting_B01_M01_VCHP15 voltage to integer: 0xf6 = "0,600V"
*[]

tvx
-----
**** TVX ver 7.2, August 2003 ****
**** ICF Ver 9.15, Jan. 2006 ****
...Configured from /home/det/p2_inod/tuxrc
Connecting to camera: host i.p. = 127.0.0.1, port no. = 41234
Waiting 20 sec for camera to boot - 'esc' to quit
# Glossary updated 16:11:19 09/15/05
# p2_inod/config/default.gl
#
# ChB 26.1.06 redefinition of exposem
define i, saved = "save \"default.gl\""
#
# ----- Readback/Calpix/Expose & Co. -----
#
define i, showing = "ingonly imadisp"
define i, rbd = "cam ingnode p:selmod i:cam fillpix [bits];wait;wait 0,5;
  showing"
define i, calibdet = "cam ingnode p:selmod i:cam calibrate;wait;wait 0,5;
  showing"
#Classic expose
define i, expose = "scan tz:cam ingnode x:cam ninages 0;expt=[tz];exp;wait4ing;
  wait 0,1;displ"
#define i, exposem = "scan tz:cam ingnode x:cam ninages 0;expt=[tz];while
  (nokey){exp temp;wait4ing;wait;displ temp.tif}"
define i, exposem = "scan tz:cam ingnode x:cam ninages 0;expt=[tz];while(nokey)
  {exp temp;wait [tz];displ temp.tif}"
define i, calpix = "scan x,y:cam cpix [x] [y]"
define i, calpix_x = "scan x,y:cam cpix_x [x] [y]"
#
# ----- nakepat -----
define i, bits=0x3367
#define i, bits = 0xf267a
#
# ----- Other -----
define i, autodefault = "autoname \"p2_inod/images/image_\"
define i, tracking = "while(nokey){wait4ing;wait 0,1;displ default;nokey;
  defaultin 0 0 486 194}"
define i, trinchip = "scan v:cam tria_all [v];cam fillpix"
#
# ----- dacs -----
define i, setdac = "set vtrw 1.8;set wadj 1,156;set vcca 0,5;set vrf5 0,7;set
  vrf -0,2;set vcal 0,3;set vdel 0,3;set vcomp 0,6"
define i, setvcomp = "scan v:format 1:for(ch=0:ch<15;ch++){set vcomp[ch] [v]}"
#
# ----- macros -----
define i, tria_load = "get \"p2_trin_load.gl\""
define i, showme = "scan f:rawimagerin [F] int 0 487 135 32;displ int 0 200 2"
define i, selmod = "scan m;if (n){prog chsel 0xffff}else{prog chsel 0x0}"
define i, trinmod_x = "get \"p2_trin_mod_x.gl\""
#
# ----- commands -----
setdac
*[]

```

Figure 13. Screen after runtux has initialized the detector and opened the Camserver and TVX window.

The ammeter on the power supply should now show approximately 2.8A.



Should the ammeter show more than 3 A, type the command **setdac** in the TVX window. Should the current remain still high, turn off the power supply immediately. Check the cabling and start again.

9 Description of the directories

In the default setup, all data for the use of the PILATUS 100K detector system is in the directory /home/det/p2_1mod.

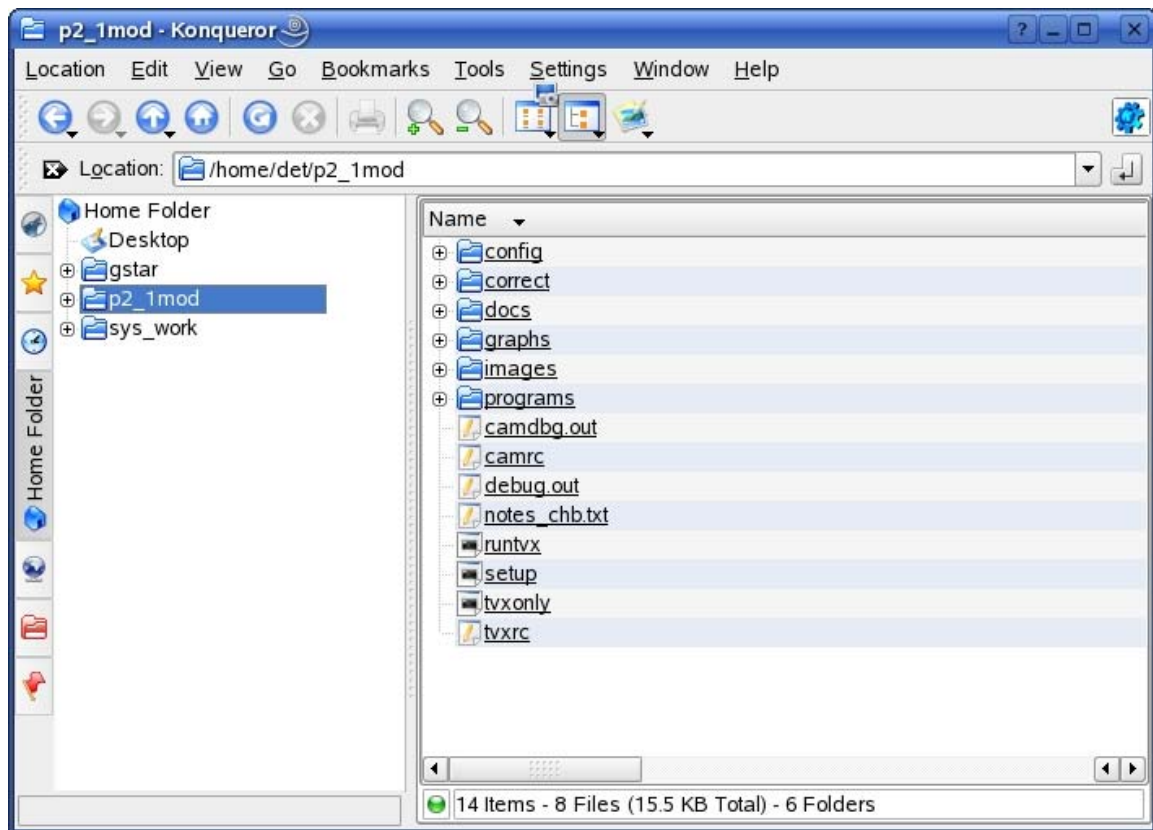

Figure 14. Relevant directories and folders.

Directory	Description
config	All glossary (.gl) files for the detector
correct	Correction files
docs	All relevant documents and the user manual
graphs	All graphs are stored by default in this directory
images	All images are stored by default in this directory
programs	The complete program code for TVX and Camserver

10 How to use TVX

10.1 Main commands

TVX is a powerful tool for data acquisition and analysis and has a complete description of all commands, which can be accessed through the *help* command.

This section describes only the most commonly used commands in TVX. All commands are case-insensitive; however, filenames are case-sensitive.

An 'object' in TVX may be an image or a graph. Many commands, such as *move*, will work on objects of either kind. Objects may be combined with standard arithmetic operators (+, -, *, /, +=, etc.), logical operators (<, >, <=, >=, |, ||, &, &&) and special operators (<<, >>, !, :, <<=, etc.) in arbitrarily complicated expressions to perform sophisticated analyses and to construct custom scripts. In case of doubt, try it out – you can't hurt anything.

Figure 15. The 'menu' of TVX.

Many commands in TVX or Camserver require an input value or argument. Without the declaration of a value, the currently set value is shown.



In this manual *input values* are shown in *Italic*.

Command or Macro	Description
menu	Shows all commands It is divided in 4 parts: <ul style="list-style-type: none"> • TVX reserved symbols • TVX defined commands • Macros, saved in default.gl • Variables
help <i>command</i> -or- man <i>command</i>	Shows the helptext for the <i>command</i> . Help <i>help</i> is a good way to start. Help "gr*" will show all commands beginning with 'gr'; the quotes are required, else the system takes "*" to mean multiplication.
ESC-button	Stop a running task and return to the TVX line interpreter
CTRL-C	Full reset of TVX
cam k	stops the running Camserver processes
rbd	Read Back Detector. Self test of the digital part of the detector. Sends a

Command or Macro	Description
	digital pattern to each pixel, reads it out and displays the image. Every pixel should show 1000 counts.
calibdet	Self test of the detector. Sends 100 calibrate pulses to the analog part of the detector, reads back the recorded values as an image and displays the result. Every pixel should show 100 counts.  Use this command always after a startup. Should the pixels not show 100 counts, repeat the command. If the image is black, type setdac, then repeat the command. In case this tests fails, turn the power supply of, close the TVX and Camserver windows and start up again.
imagepath <i>path</i>	Image Path Without the input of a path it displays the current default path. With a declaration it changes the default path for images. The imagepath command also sets the autname to the new path.
grafpath <i>path</i>	Graphs path Display or change the default path for graphs. The keyword 'grafpath' can be used in expressions as [grafpath]
exp <i>filename</i>	Make an exposure. If filename is not given, TVX uses the next automatic filename. The files created are saved in the folder specified in imagepath.
expose <i>exposure time</i> (in seconds)	expose 1: makes an image with an exposure time of 1 sec. shortest exposure time: > 10 us, 0.00001. Shows the exposed image immediately on completion.
exposem <i>exposure time</i>	continuous camera mode without saving images. Takes images until any key is pressed. The last image is stored in temp.tif
disp <i>filename</i>	Display an image. Opens up to 3 windows for successive invocations.
disp1 <i>filename</i>	Displays an image using only one window. Useful in loops.

Command or Macro	Description
<code>graf <i>fn1</i>[<i>fn2</i>[<i>fn3</i>]]</code>	Graph up to 3 graphs in a window
<code>show <i>variable</i> -or- show <i>string</i></code>	Shows the content of a variable or a string
<code>define</code>	DEFINE name="instruction1; instruction2;....." Defines user symbol name and value. E.g. define tpict="zpict; move imt=im3" defines symbol tpict as a combination of 'zpict', and the built-in move instruction.
<code>CaptureIM <i>filename</i></code>	Capture image to filename captures a displayed image (and its zoom) as a .ppm (portable pixmap) file, including coloration and contrast adjustments.
<code>CaptureGR <i>filename</i></code>	Capture graph to filename Captures a displayed graph (and its zoom) as a .ppm (portable pixmap) file.
<code>connect [<i>ip_address</i>]</code>	Connect the socket connection from TVX to Camserver.
<code>disconnect</code>	Disconnect the socket connection from TVX to Camserver. For example, so that a beamline operating system like EPICS can take control over the Camserver.

Description of the image display

After an exposure, the image will be shown in a separate window, the image window.

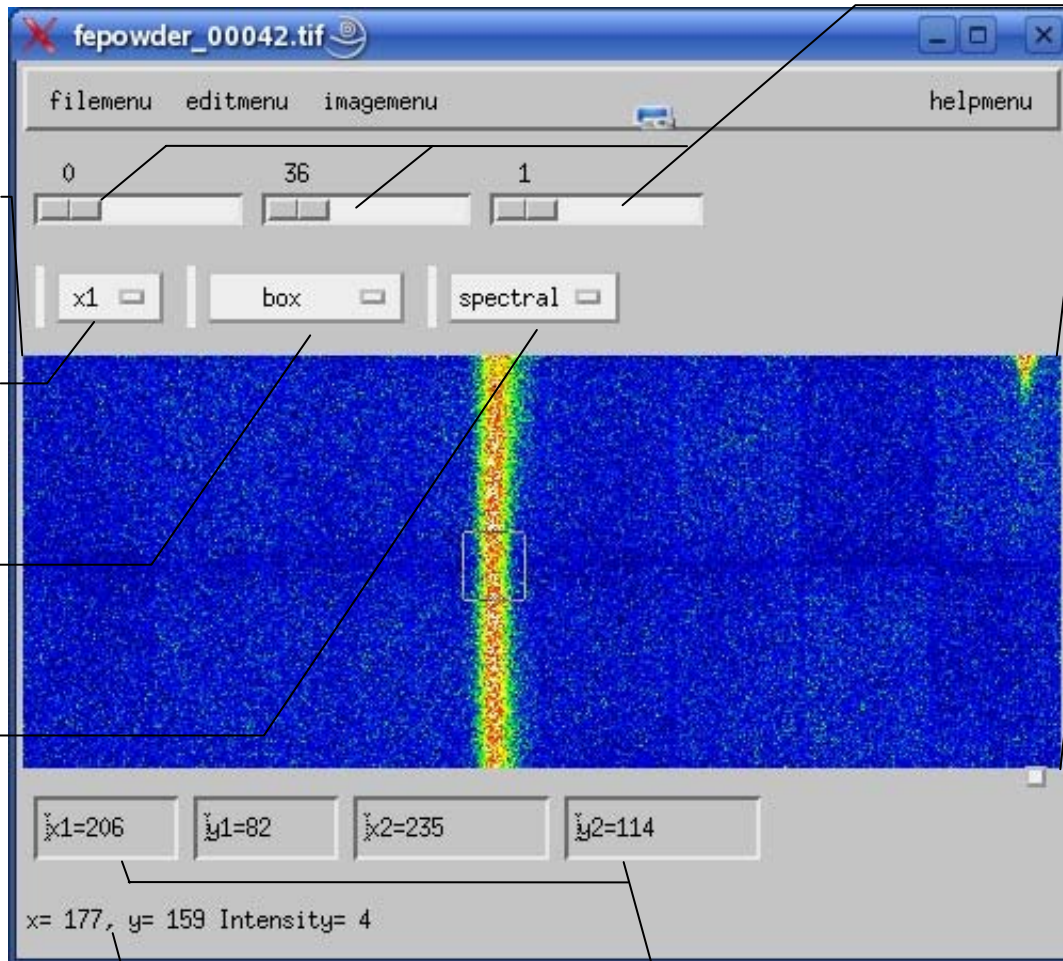

Coordinate:
(0,0)

Zoom factor

Selection
tool

Color
scheme

3 sliders to
control the
contrast and
the color:
low, high,
factor

Coordinate:
(487,0)

Coordinate:
(487,195)

Numerical entries for the selection
tool.

Actual position of the cursor and the
intensity of the pixel

Display tools	Description
(sliders)	<p>Define the color and the contrast of the image. For every value of a pixel a color from a lookup table will be displayed.</p> <p>With the two left sliders the cut off for the low and high values can be set. Values outside this range are displayed with the same color.. The third slider defines the contrast factor.</p> <p>The sliders can be moved with the mouse or by putting the mouse on the slider and adjust the value with the left and right cursor buttons. They can also be set from the command line using the <i>disp</i> command.</p>
zoom	<p>A magnification can be chosen and the enlarged area is shown in a new window. The zoom outline in the main window can be positioned by clicking or dragging with the mouse with the right button depressed.</p>
Selection tools	
pointer	normal pointer
annulus	<p>Allows analysis of circular areas.</p> <p>The sizes of the circles can be adjusted with the mouse or directly by the setting the values in the image window.</p>
box	<p>Allows analysis of rectangular areas. Move the box with the right mouse button pushed or put the center of the box with the left mouse button. The size of the box can be adjusted with the mouse or directly by setting the values in the image window.</p>
butterfly	<p>Allows analysis of special shaped areas.</p> <p>The shape of the area can be adjusted with the mouse or directly by the setting the values in the image window. The circle is only for alignment purposes.</p>
resolution	<p>Resolution circles for crystallographic patterns. Calculates the resolution of the image. The correct parameters for the detector should be set in the detector setup file or from the command line.</p>
Display mode	
greys	color lookup table with gray scale.
spectral	color lookup table with a spectral distribution (blue and black near zero, red fading to pink and white at the high end)

Display tools	Description
thermal	color lookup table going from blue through yellow and red, but no greens
decades	The values between Min and Max are displayed linearly, but with the scale wrapping around Scal number of time. Thus, Scal = 1 is linear, Scal = 5 covers the range Min to Max with 5 linear segments going from 0 to 255, 0 to 255, etc. This gives lots of artificial contrast that is good for smoothly-varying SAXS data, but is otherwise rather non-intuitive.
power	The image is displayed between Min and Max using the transfer function: $(\# \text{ grays}) * ((\text{value} - \text{min}) / (\text{max} - \text{min})) * (\text{Scal} / 15)$ # grays is usually 256. Thus, a small value of Scal (~3) gives a very steep transfer function at low values, and very little contrast at high values. Scal = 15 is a linear transfer function; Scal > 15 is nearly useless.
reverse	The values are reversed - x-rays in the image become black rather than white. Useful for crystallographic images.

Several test images and graphs are included in the system. Try the following:

imagepath examples
 disp testimg.tif
 disp gray20bit.tif

grafpath examples
 grafdemo

More examples are in:
 /home/det/p2_1mod/programs/tvx/test/images -and-
 /home/det/p2_1mod/programs/tvx/test/graphs



Example: Butterfly selection tool

This selection tool is useful for straight line integrations (densitometer traces) and for integrating small angle scattering patterns from either a line or a point x-ray source.

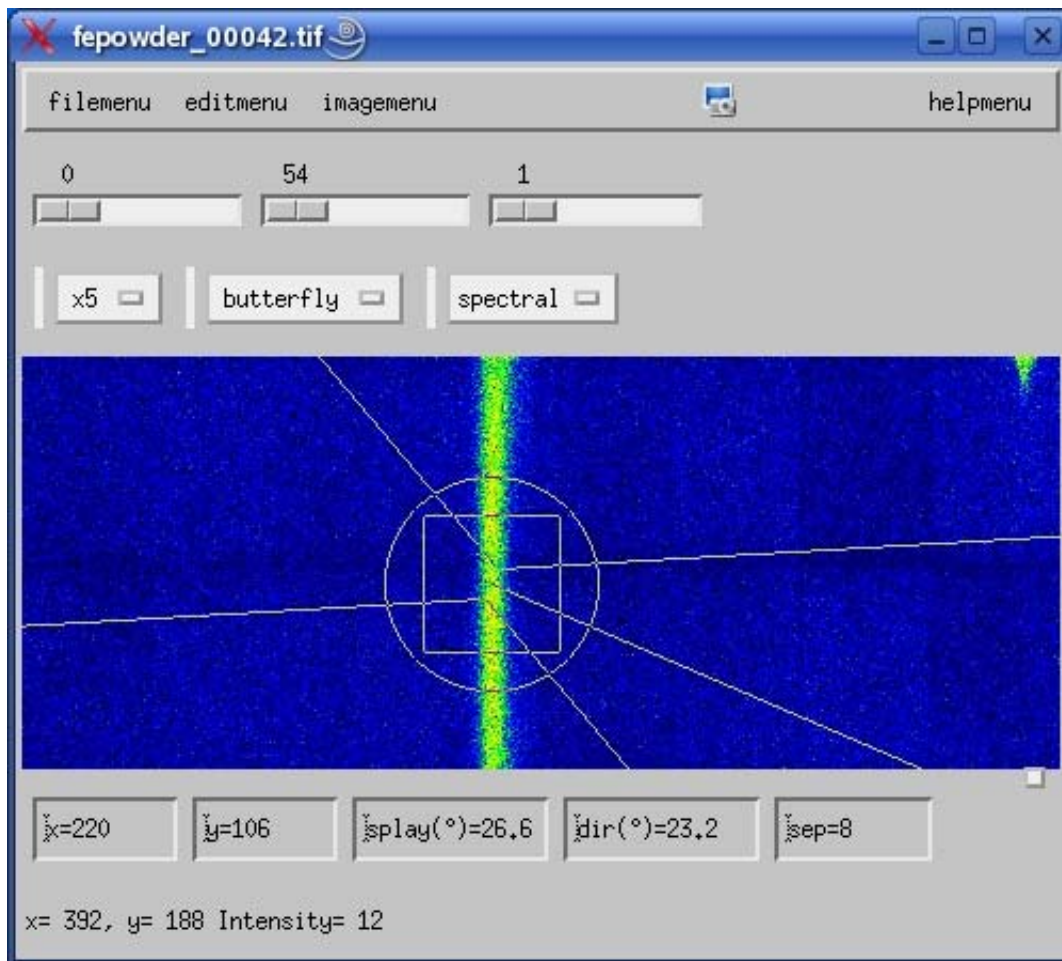

Figure 16: Example of a the butterfly selection tool

The size and position can be adjusted directly with the mouse or by typing the values directly into the boxes. The circle is used as a positioning aid. Use the keyword *integrate* in the tvx window to display the result.

10.2 Image formats

Due to the high dynamic range of 20 bits (1'000'000) of the PILATUS detectors, images are stored as 32 bit (unsigned) integers. These images can be viewed and analyzed with TVX or other image viewers. Many viewers do not support 32 bit TIFF files; however they may be read in IDL or MATLAB.

The default image file-type for TVX is set in tvxrc; however, any file-type can be specified explicitly. Camserver has no default, so the file type must be specified explicitly for each exposure.

TVX supports the following image formats:

Format	Description
.tif	32 bit TIFF files
.edf	ESRF data format
.cbf	Crystallographic binary format
.img	raw data format

10.3 Analysis commands

TVX offers a large variety of image analyzing and processing commands. The most important commands are described in this document.

All created data are stored in the graphs directory.

Command	Description
<code>move <i>fn1=fn2</i></code>	The basic image manipulation command. In the simple form shown, this copies an image to a new name or directory. However, <i>fn2</i> can be any arithmetic expression of images and constants.
Integrate	integrate the pixels selected by the current selection tool - box, butterfly (includes straight-line case), or spot (annulus tool) - and show the resulting graph. Usage: integrate [IM] [graph_name] For the butterfly, the graph name can be given as the second parameter; in this case the image name must be specified. In other cases, the default image is used if no image is specified.
<code>histogram <i>lo hi int</i></code>	Histogram the pixels selected by the box tool on the image. Alternatively, specify the image and region-of-interest on the command line. Usage: histogram [IM] [<i>lo hi int</i>] [<i>x1 y1 x2 y2</i>]

Command	Description
	<p>[graph_name], where lo is the first value to use, hi is the last value, and int is the interval. If IM is not specified, the default IM is used. [x1 y1 x2 y2] are the coordinates of the box to be histogrammed. If no graph_name is specified, the histogram is placed in file 'hist[n].dat' in the default graph directory, where n rotates through the values 0...5. This file can be then be moved to a permanent file by a command such as "move myhist=hist1". The histogram parameters are remembered, so subsequent operations with the same parameters can be obtained by just typing 'histogram'. If the coordinates are specified on the command line, the parameters must also be specified. If the file name is specified, either the image name must also be given, or 3 (or 7) numeric parameters must be specified. In the integral mode, the integral is written to 'hist[n+1].dat'. if the name is specified, it is appended with "_i" for the integral.</p> <p>See also 'histset'</p>
box	<p>Print statistics from the current box selection tool on the image. Alternatively, specify image name and box coordinates on the command line.</p> <p>Usage: box [IM] [x1 y1 x2 y2] If IM is not given, the default IM is used. [x1 y1 x2 y2] are the coordinates of box to be examined. If not given, use the box selection tool on image. If given, the box selection tool is created or updated on the image, if it is displayed. If the box is set with the mouse, 'box' and 'integrate' give the same result. Several system variables are set: counts (total counts in box), area, mean, minimum, maximum, stdev (rms), var (variance), xcen & ycen (centroid), box_x1, box_x2, box_y1 & box_y2 (corners of box).</p>
format n1[.n2]	<p>Control the number of digits to be printed (n1) or the number of decimal places (n2).</p>
deleteallobjs	<p>Delete the TVX record of all objects – the objects themselves are untouched. Images are stored in the TVX memory up to the limit specified in tvxrc, which can consume significant resources; use this command to free up memory. In addition, one can create with identical names in various directories. To avoid the necessity of always specifying full path names, use this command to clear the TVX memory.</p>

Command	Description
deleteobj <i>filename</i>	Deletes the specified object from the TVX memory.
maskimg	Specify a mask image to be used by many TVX commands, such as box and histogram. See below.

10.4 User defined commands

TVX supports complex C-like commands in the command line.



Example:

To display a series of images as a movie:

```
format 2; for (i=0;i<100;i++){disp1 image_000[i]; wait 0.5}
```

Displays image_00000 to image_00099 and waits 0.5 seconds between each picture. The brackets [] mean to substitute the enclosed argument as text with the number of digits specified by the format.

With *define* one can create custom commands for the current session and eventually save them for reuse.



Example:

```
define test1="format 2; for (i=0;i<100;i++){disp1 image_000[i]; wait 0.5}"
```

Command	Description
define <i>name=string</i> define <i>name=value</i>	Define a name (value or command) which can be used in the current session. They are not saved when tvx closes.
save " <i>myfile.gl</i> "	Save the currently defined commands in <i>myfile.gl</i> as text. Such files are called glossaries. Glossaries may also have executable commands edited in following all the definitions; these are preserved when the file is overwritten.
get " <i>myfile.gl</i> "	Load the definitions from <i>myfile.gl</i> , and execute any commands appended after the definitions.

11 How to use Camserver

Camserver is a completely freestanding program that controls the detector and provides a simple user interface for "atomic" (single function) commands. It is intended to provide a spartan, but fully functional, low level interface to camera hardware.

To get help on the Camserver commands use the help facility of TVX. All commands in camserver (unlike TVX) can be abbreviated to the minimum number of letters that make the command unambiguous; below we use only the full names for clarity. As in TVX, commands are case-insensitive, but pathnames are case-sensitive.

11.1 Main commands

Command	Description
menu	Shows all commands
exptime	Set the exposure time (10^{-5} to 10^6 sec)
exposure [<i>filename</i>]	Make an exposure with the exposure time predefined with the command <i>exptime</i> . The format of the file is determined from the supplied extension – see above. The file is stored relative to the path defined by the <i>imgpath</i> unless an absolute path is given.
exttrigger [<i>fname</i>]	Start exposure with above define parameters after receiving an external trigger and store images [<i>fname</i>] (see section 14)
extenable [<i>fname</i>]	Start exposure defined by external exposure and store images in [<i>fname</i>]. (see section 14)
help <i>exposurenaming</i>	Type this in the TVX window for a discussion of how exposure series are named.
imgpath [<i>path</i>]	
dcb_init	Re-initialize the DCB.

11.2 Variables

The following variables can be viewed just by typing them; all times are in seconds.

Variable	Description
<code>exptime [time]</code>	Query or set the exposure time
<code>nimages [N]</code>	Query or set the number of images.
<code>expperiod [time]</code>	Query or set the exposure period for serial exposures. The exposure period must be at least 3 ms longer than the exposure time.
<code>imgpath [path]</code>	Query or set the default imgpath
<code>delay [time]</code>	Query or set the external trigger delay. This is the time to wait after the external trigger before taking the first image (see section 14)
<code>nexpframe [N]</code>	Query or set the number of exposures per frame. This is the number of times to enable the detector before reading out the image (see section 14)

12 Special procedures

12.1 Exposures series

With the PILATUS 100K detector system, it is possible to take image series with a frame rate of up to 200Hz and a shortest exposure time of 10 μ s. All timings are controlled by a crystal clock on the DCB.

Define the following variables in the Camserver window:

- ExpTime (expt)
- Number of images (ni)
- Exposure period (expp)

The exposure procedure can be started either from the Camserver window with 'exposure *filename*' or from the TVX window with 'expo' (a macro). The images are stored according the defined imagepath and filename; without a defined filename, the images are stored in the next automatic filename.

12.2 Adjusting the threshold level

To avoid fluorescence radiation, the threshold of the detector can be adjusted. This adjustment is done in the TVX window.

Command	Description
setvcmp <i>value</i>	Values for setvcmp between 0 .. 0.8.

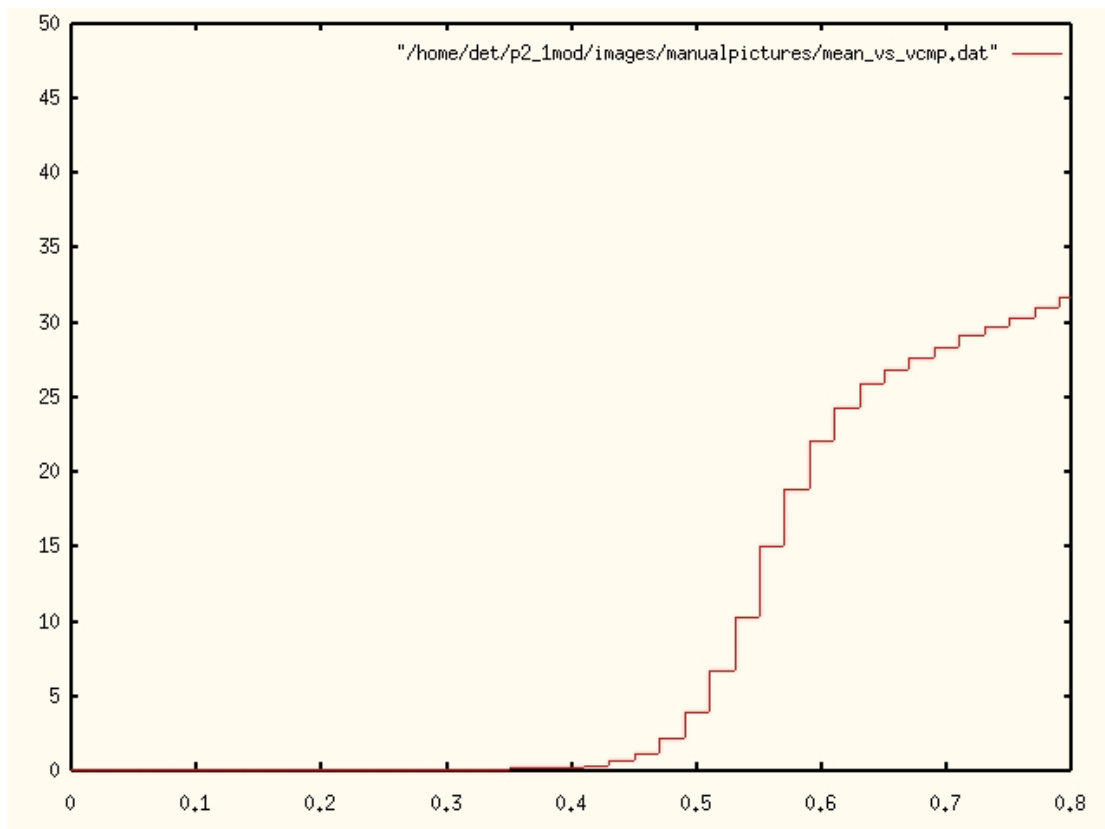

Figure 17. Value of Vcomp (x) and mean number of counts per pixel (y).

Zero sets threshold level very high and no x-rays are registered; 0.8 sets threshold level very low and all x-rays and some noise are counted.

12.3 Adjusting the analog amplifier

The frequency response and consequently the count rate of the analog amplifier can be adjusted.

Command	Description
setvrf <i>value</i>	Values for setvrf between -0.15 and -0.3.

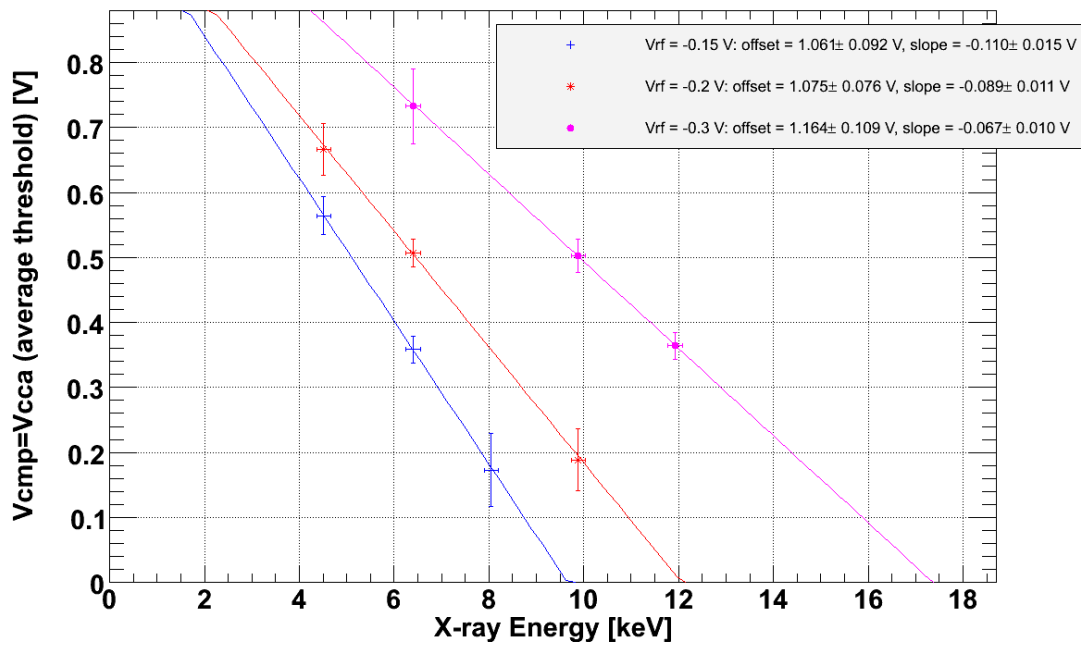

Figure 18. Calibration curve for different amplifier settings Vrf.

13 Calibrating the detector

13.1 Principle

The calibration of the PILATUS 100K is necessary, because every pixel has a different characteristic, sensitivity and count rate due to voltage drops and nonlinearities in the analog amplifiers. To correct this irregularity, every pixel can be adjusted with 6 trimbits (6-bit DACs) which allow $2^6 = 64$ different values. In addition the magnitude of the influence of these trimbits can be adjusted by the voltage V_{trm} .

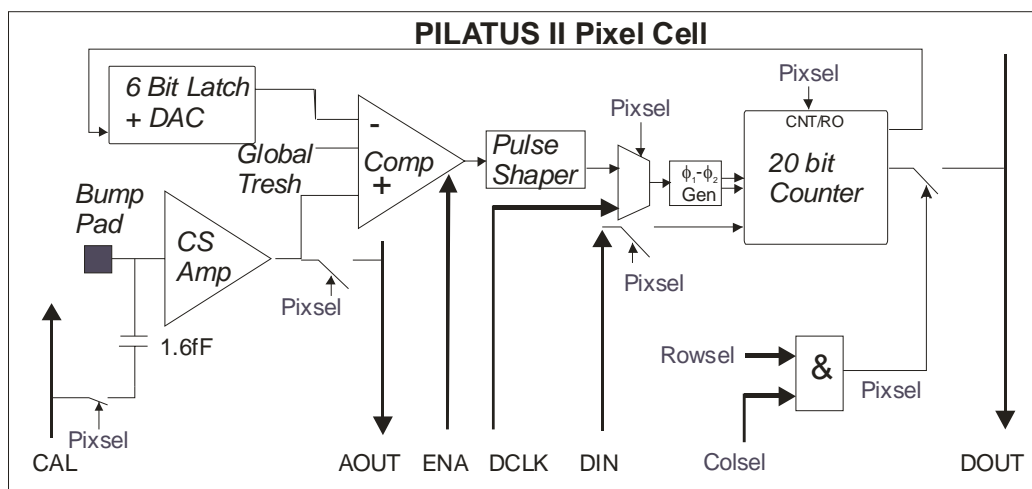

Figure 19. Block diagram of the CMOS read out chip.

The detector is calibrated as follows:

Irradiate the detector with a uniform field of x-ray's in a energy range between 8-18 keV.

Comparator (V_{cmp}) scan

Set all trimbits and V_{trm} to zero and increase V_{cmp} from 0 to 0.8; recall that 0.8 corresponds to a low energy threshold, 0 to a high threshold. The result is a V_{cmp} calibration curve.

Set V_{cmp} to the value where the detector starts to count

V_{trm} scan

Set all trimbits to high and increase V_{trm} until all pixels are counting less than half of the value at trim=0; generally almost all pixels will be off at this point. Keep this value.

Trimbit scan

With these values, record images for every trim setting from 0 to 63. The result is a calibration curve for every single pixel. The trimbits are set to the value of the inflection point of this curve.

13.2 Creating a trim file

The detector is irradiated with uniform x-ray illumination with a defined energy, the calibration is done and the result is stored in a trim file. For different energy levels, different trim files have to be created. Once a trim file is created, it can be loaded for the appropriate x-ray energy to achieve a uniform measurement.



To simplify the calibration, the script *p2_trim_det.gl* guides you through the whole calibration process.



Depending on the flux of the x-ray source this calibration may take several hours.

To create a trim file for a detector module you should run the following command in the TVX window: `get "p2_trim_det.gl"` (the quotation marks are required).

You will then be prompted to enter a name for the directory in which the trim files will be stored; this should be a directory that does not already exist. A format is suggested but any valid directory is acceptable. This directory will be created in the images directory: `newmod="mxxx_trim__ddmmyy"`



Explanation:

mxxx: preferably set the module number of the detector

ddmmyyyy: set the date of the trim

Next you will be prompted to enter the quick test directory name for the module you are trimming. This directory name is assumed to exist in your images directory, where all data from the manufactory calibration has been saved. In case there is no such directory, then you will need to supply the full path to the module's quick test directory: `quicktestdir="mxxx_ddmmyy_quick"`

The system will now run through the Vcmp scan. The next prompt will occur in about 5 minutes. You are now asked to enter a value of Vcmp (comparator voltage) such that all pixels are counting 100% of the incoming X-rays. The appropriate level of Vcmp can be determined from the "mean_vs_vcmp" graph (Figure 20). Set vc to a level well above the inflection point of the S curve: e.g. Vcmp = 0.6.

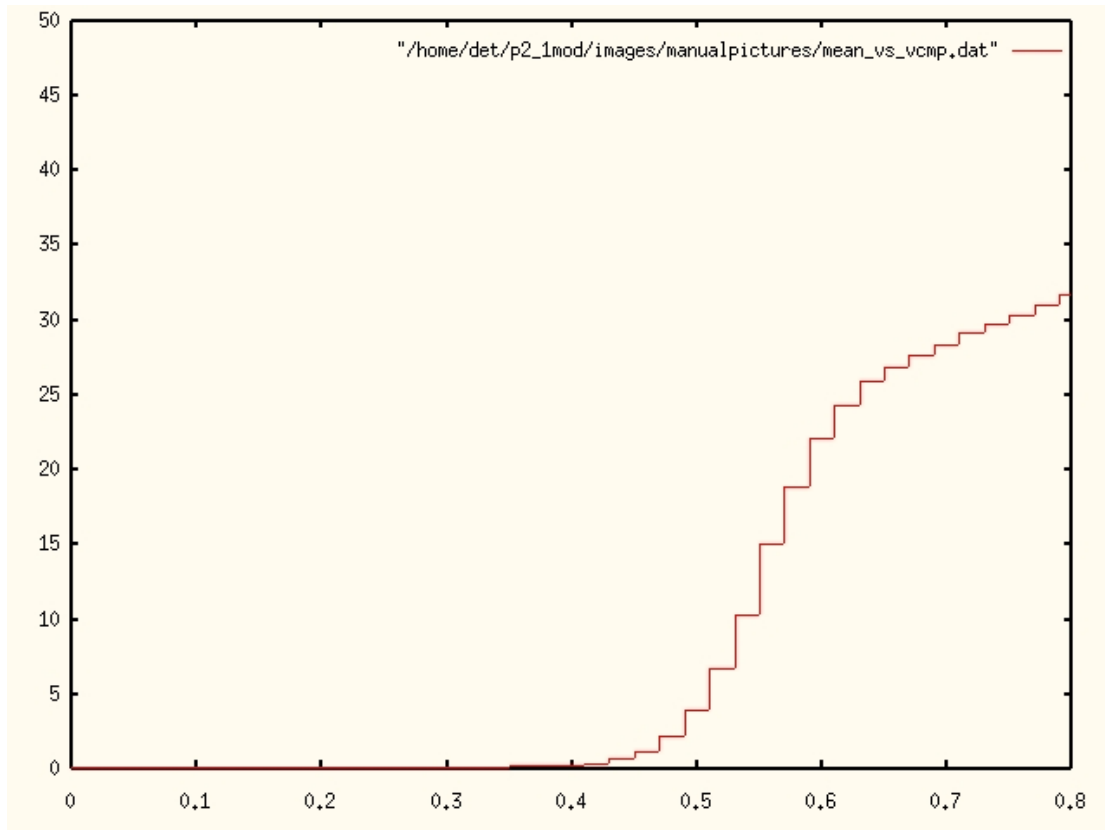

Figure 20. Result of the Vcmp scan.

The system will now run through a Vtrm voltage scan. All 6 trimbits are set to 63 and Vtrm is varied. The next prompt will occur in about 5 minutes. You are now asked to enter a value of Vtrm such that all pixels are counting 0% of incoming X-rays. The appropriate level of Vtrm can be determined from the “mean_vs_vtrm” graph (Figure 21). Set Vtrm to a level well below the inflection point of the S curve, e.g. vt=1.4.

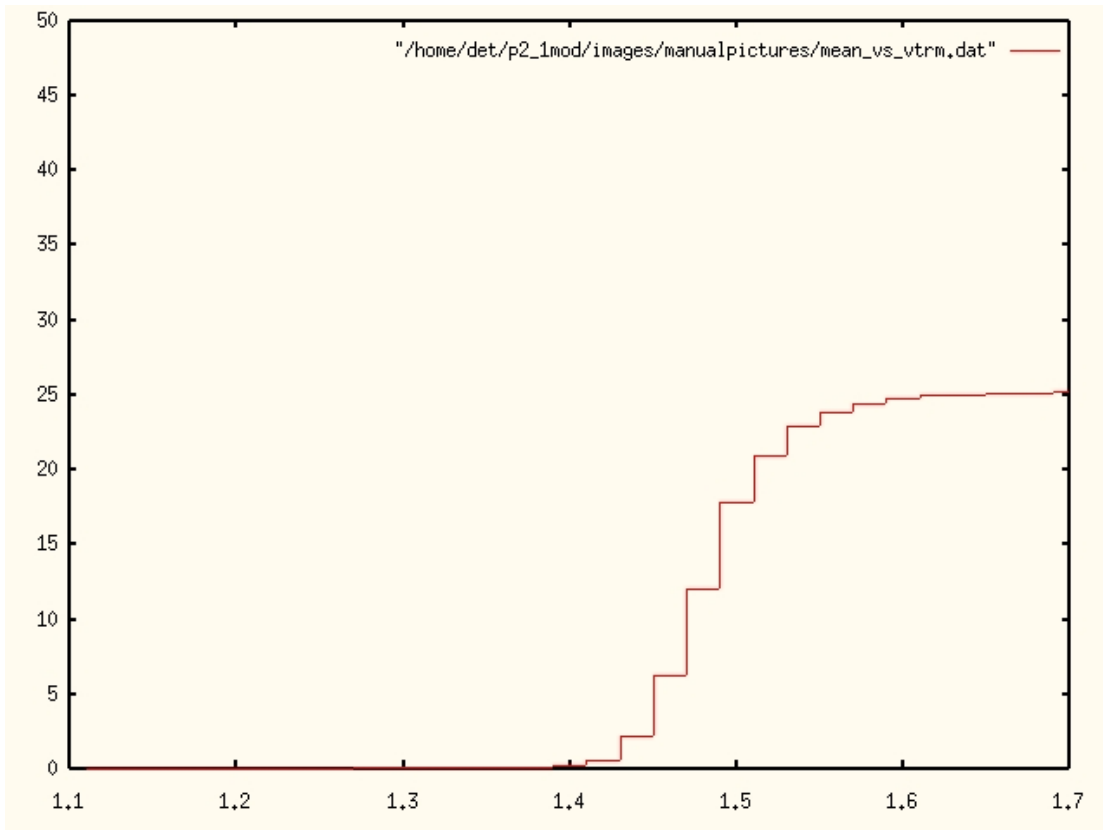

Figure 21. Result of the Vtrim scan.

The system will now run through a trim bit scan and vary all 64 possibilities of the trimbits. The next prompt will occur in a few hours depending on flux of the x-ray source.

Trimming of the module at the current X-ray energy is now complete. You are asked if you would like to load the trim settings you have just taken for this module. Set the variable flag to equal 1 to do this and the load trim glossary will be started: flag=1.

A faster way to generate trim-files is to use the following lookup table for the recommended values for Vtrim and Vcmp

Settings for Vrf = -0.2		
E [keV]	Vcmp0 [V]	Vtrim [V]
6	0.75	1.38
8	0.6	1.36
10	0.44	1.34
12	0.3	1.32

Table 1: Recommended Values for Vcmp and Vtrim for standard settings and energies between 6 and 12 keV.

These values can be used together with the glossary *trimscan_only.gl*, where you directly enter Vtrim and Vcmp for the targeted energy.

13.3 Loading trim files

After creating the trim files for a module and a specific x-ray energy you are able to load them at anytime. This can be done either after the trim scan glossary has finished or by executing the following command in the TVX window: get "p2_trim_load.gl".

You will be prompted to enter the directory name in which the module's trim files have been saved. This directory name is assumed to exist in your images directory; if this is incorrect you will need to supply the full path to the module's trim file directory: newmod="mxxx_trim_06mmdd".

The trim files will be loaded and a comparison between loaded trims and assigned trims is made. If everything has worked correctly you should see exactly 100 counts per pixel.

Command	Description
trimchip <i>N</i>	Set all trimbits to <i>N</i>
show setdac	Shows the command used to set the DACs

13.4 Mask files

Setting a mask image is useful when you are looking at the statistics of images from the detector. Pixels in the detector that are either dead, too noisy or behave in a non-desirable manner can be masked out. After a pixel has been masked, it will no longer be considered when using statistical routines to analyse your image so that your results will not be distorted by pixels behaving incorrectly.

A mask file is an image file that uses only two distinct values for each pixel. Every pixel that is to be masked out is given a value of 0, every other pixel is given a value of 1. You can create a mask file from another image by using the command "mkmask".

Command	Description
mkmask	<p>Make a mask from an image between two limits, inclusively.</p> <p>Usage: mkmask [IM] [IMout] low high</p> <p>The result is a mask of 1's and 0's which can be used to select pixels of an image by multiplication. If no image is supplied, the default is used. Note that a float input object returns a 32-bit integer mask.</p>

Command	Description
	<p>Because the generated file is a normal image you can use any of the image manipulation tools supplied in TVX to alter your mask image if you wish.</p>
Maskimg	<p>Declare, inquire about or turn off the current mask image.</p> <p>Usage: maskimg [im] -or- maskimg 0</p> <p>If present, the mask is used to blank out bad pixels in statistical routines such as box, integrate, spot & histogram. Zeros in the mask are excluded from the analysis, non-zeroes are included.</p> <p>With no argument, displays the current mask image name, if any. With numeric argument (e.g. 0), turn off the mask image.</p> <p>You can also check the current mask image by using the command "maskimg" with no arguments, the path of the current mask image will be shown or a message saying "Mask image is not set" if there is no mask image being used.</p>
pixlfill [IM] value	<p>Set pixels in <i>IM</i> to <i>value</i> using the current box as a template. This permits you to manually alter a mask image based on observations on a different image.</p>



If the command "deleteallobjs" is used after you have loaded a mask image your maskimg will be reset; of course, the stored image is untouched.

13.5 Setting a trimmed threshold

In order set the trimfiles for an arbitrary threshold between 6 and 12 keV the following method is used. A set of trimfiles for standard settings is used, which are stored in the directories T5_9, T8_1 and T9_9. For the target threshold T, the closest available trim_file is now loaded and vcmp is calculated to match the target threshold T. This procedure is performed by using the glossary *set_threshold.gl*

This simplifies the operation and makes sure that the detector is always used trimmed. In cases where fluorescence radiation from a sample should be suppressed it is to use this glossary. The threshold should be set about 0.5 keV above the K_{α} -line of the emitted X-rays.

13.6 Creating a flat field correction image

Intensity correction images are created with the glossary "p2_intc_gen.gl".



Start this glossary in TVX by issuing the command get "p2_intc_gen.gl".

Follow the instruction in the TVX window. You will be asked to supply a module number, this will create a directory under your images directory with the name you supply; ensure that this is a new directory. You will then be asked for the quick test directory of the module you are using. This is used to obtain the appropriate DAC settings.

Next you will be asked to ensure that the X-ray source is off, after doing so continue with the glossary. A 'rbd' image will be taken followed by a 'calibdet' image, if these images are correct continue.

You are now asked if you would like to load the trim-files, start the load trim files procedure, set 'flag=1' and continue.

Now enter the trim file directory you wish to trim the module with, this procedure is described in 13.3 Loading trim files.

After the trim loading section has completed you will be given an opportunity to change the DAC settings if necessary.

The X-ray testing section will now begin, and you will be asked to turn on your X-ray source. A 1 second exposure will be taken and a mean count rate for the detector will be obtained. You are given the opportunity to redefine the area being used to obtain the mean value. Using this number an exposure time will be calculated to obtain a 10,000 X-ray count image. You are given the opportunity to change the exposure time if required.



The longer the exposure time, the better the statistics.

After the data has been taken you will be shown a histogram and asked if you would like to change the cutoff levels that have been set. These levels will be used to create a mask image. Both a mask file and a flat field correction image will be created and copied into the directory ~/p2_1mod/correct. The final step will delete the working directory created under the images directory.

13.7 Using the flat field correction image

To set the flat field correction image in TVX, issue the command "setint correction_image". By default the file is assumed to be in '~/p2_1mod/correct/'. By explicitly stating the path and image you can specify an image in a different directory. Issuing the command "setint" without any argument will list the currently used correction image, if any.



The flat field correction image is not automatically applied to the images that you take. To apply the correction to an image issue the command "move new_image=image!imi" . Where "new_image" is the new image that will be created and "image" is the image that is to be corrected.

14 External Triggering

External triggering can be separated into two different modes, these modes are “External Trigger” and “External Enable”. “External Trigger” triggers a predefined series of commands after the detector receives a positive edge whereas “External Enable” gates the detectors images on the positive signal coming to the detector.

All these commands apply to Camserver.

14.1 Command list

Variables	Description
ni	Number of images Sets the number of images to be taken after the trigger e.g. :“ni 2” for two images
expt	Exposure time Sets the exposure time for each image e.g. “expt 1” for a one second exposure
expp	Exposure period Sets the period of time allocated to take an exposure and readout the image. e.g. “expp 2” for a one second period therefore readout time is (expp-expt), the minimum readout time is 3ms
delay	Delay Sets the time to wait after the trigger to take the first image. e.g. “delay 1” a one second delay between the trigger and first image
Extt [image name]	External trigger Starts the external trigger mode and waits for the trigger
Exte [image name]	External enable Starts the external enable mode and waits for the trigger
nexpf	Number of exposures per frame This is a so called multi exposure mode. nexpf sets the number of exposures before the detector is read out e.g. “nexpf 3” exposes the detector 3 times before reading out an image of the 3 combined exposures.

14.2 External Trigger mode

External trigger mode is started with the command “extt *imagename.tif*” where *imagename.tif* is the name of the images you wish to be taken. The image name will be “*imagename_00001.tif*”. If “ni” is more than 1 the image number will be incremented for each image in the series.



The settings that are necessary for external triggering are:

- Ni
- Expt
- Expp
- delay

After receiving a trigger on the positive edge, the module will wait a period of time defined by “delay”, take an exposure of length “expt”, readout the image and after a period defined by “expp” will repeat the cycle for “ni” images.



The image number is only incremented during the trigger mode, if you reissue the command “extt *imagename.tif*” the system will start writing images from “*imagename_00001.tif*” and overwrite your existing data.

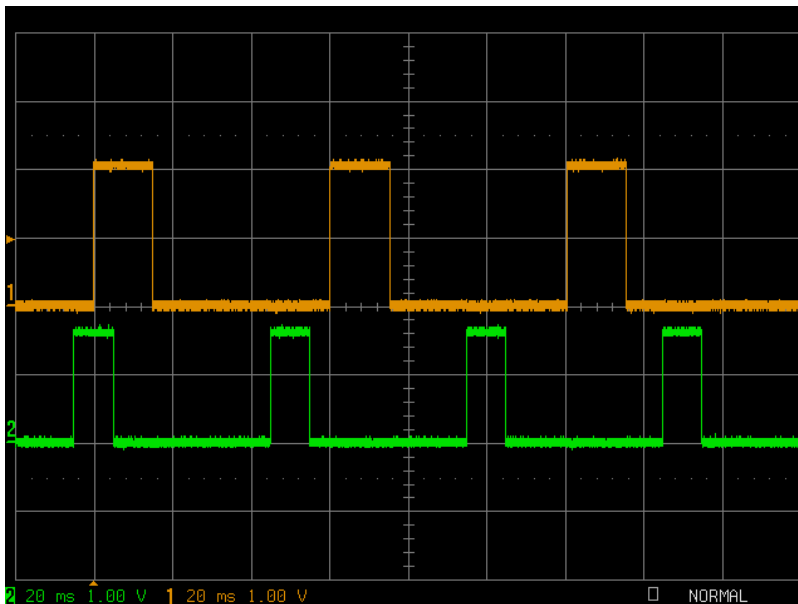

Figure 22. Oscilloscope trace of an external trigger. See text.

The upper trace is the exposure signal, the lower trace is from the pulse generator being used as a trigger. For this external trigger, “ni” is 3, the “delay” is 0.005 s, “expt” is 0.016 s and “expp” is 0.06 s. Only the first positive edge of the trigger is used.

Because the external trigger relies upon the module's internal clock signal to start the timing of the exposure, there is a delay and jitter between the trigger signal and the start of the first exposure. The maximum jitter is ~15 ns with an average delay of 177 ns.

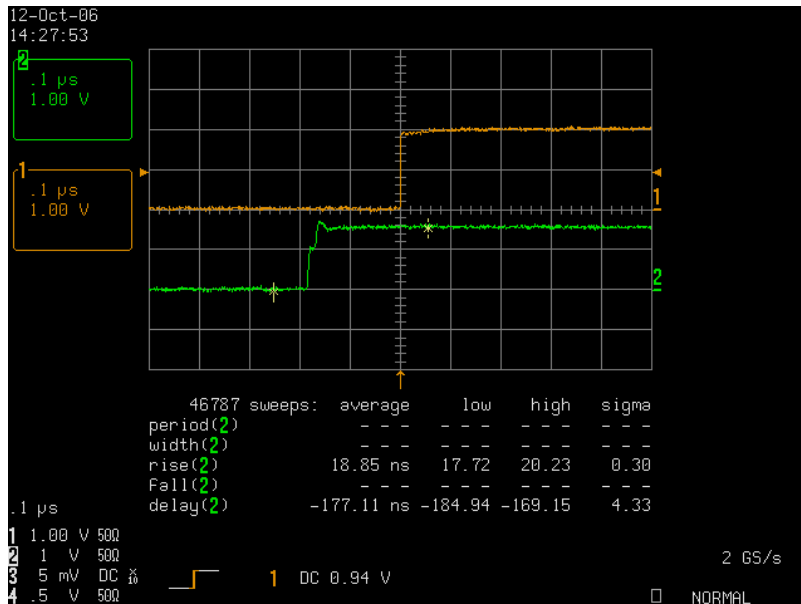

Figure 23. Delay and jitter.

14.3 External Enable mode

External enable mode is started with the command “exte *imagename.tif*” where *imagename.tif* is the name of the images you wish to be taken. The image name will be *imagename_00001.tif*. If *ni* is more than 1 the image number will be incremented for each image in the series.

After issuing the “exte *imagename.tif*” command the detector will monitor and take a number of images defined by *ni* gated on the level of the trigger pulse.



Variables “delay”, “expt”, “expp”, etc. are not used in external enable mode.



The image number is only incremented during the exposure series; if you reissue the command “extt *imagename.tif*” it will start writing images from “*imagename_00001.tif*” and overwrite your existing data.

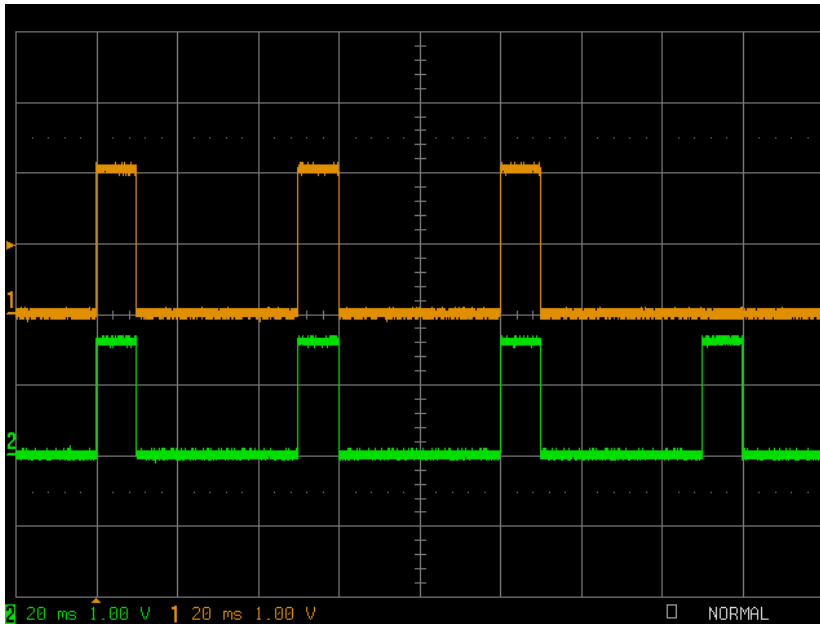

Figure 24. Oscilloscope image of an external enable.

For this external enable “ni” is set to 3.

Because external enable gates the counter directly, it does not rely upon the detector’s internal clock. This means that the delay between the enable and start of exposure is negligible and mostly given by the rise time of the enable provided to the detector. This can be seen in the oscilloscope image below.

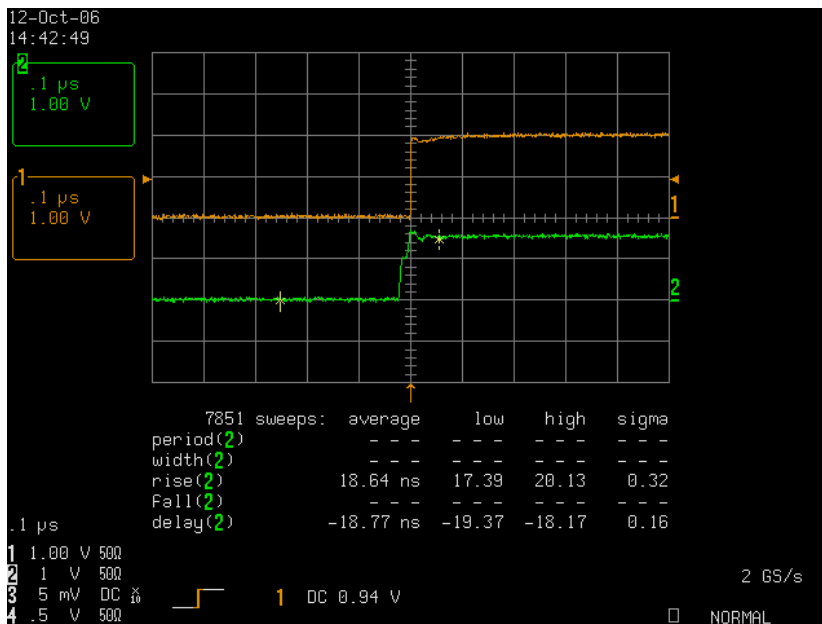

Figure 25. Oscilloscope trace of the typical delay between enable signal and exposure.

14.4 Multiple Exposure mode

It is possible to take multiple exposures in one image by setting the number of exposures with the variable *nexpf*. The default value is 1; all exposure modes use this variable. If '*nexpf 2*' is set, then the detector will take exposures in the same way as described for external trigger and external enable, but will additively bundle 2 exposures in each readout. If *ni* is defined to be 3 and *nexpf* is defined to be 4, then the detector will take 12 exposures and generate 3 images.



The advantage of this mode comes when you want to record a small number of x-rays at a repetitive fast rate e.g. at the Fempto project at the SLS. This also eliminates the need to wait 3 ms between exposures; however at least 3ms is needed for the image readout after *nexpf* exposures.

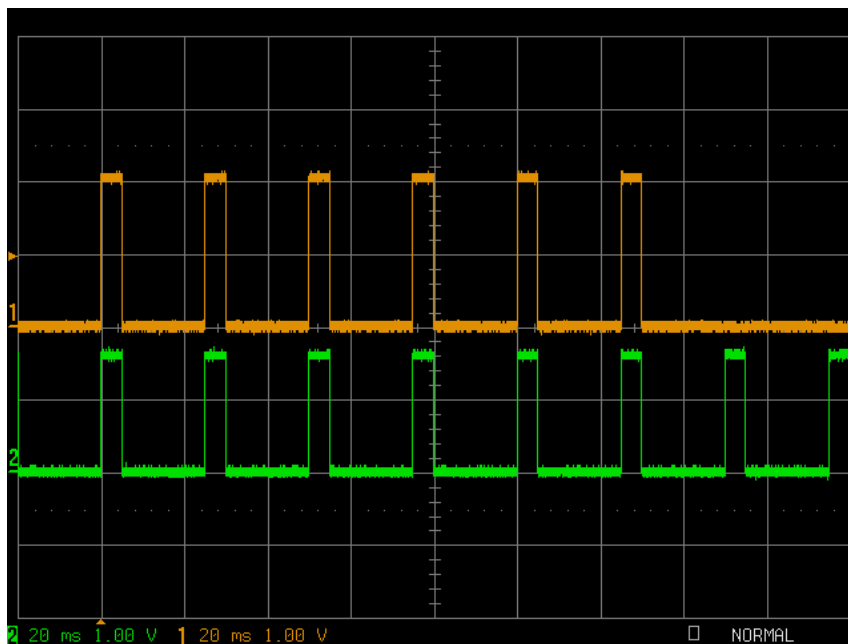

Figure 26. Oscilloscope image of the multiple exposure mode.

15 Maintenance

The PILATUS 100K detector system is completely maintenance free.
Clean the detector with a soft tissue.



Do not touch the front window of the detector.

16 Troubleshooting

In case you should experience problems with your PILATUS 100K detector system, the following overview should help you to find a solution. Note that the first image after powering up may be corrupted.

Error	Possible Cause	Solution
The ammeter shows more than 3A	<ul style="list-style-type: none"> • Detector not properly initialized. • High flux on the sensor 	<ul style="list-style-type: none"> • Run <i>the</i> commands <i>calibdet</i> and <i>rbd</i> • No action
When taking the first image the image looks strange	<ul style="list-style-type: none"> • Detector not properly initialized 	<ul style="list-style-type: none"> • Run <i>the</i> commands <i>calibdet</i> and <i>rbd</i>

17 Appendix

17.1 Table of figures

Figure 1. Drawing of the PILATUS 100K detector.....	9
Figure 2. PILATUS 100K detector with aluminum cover in place (left) and removed.....	9
Figure 3. PILATUS 100K detector viewed from the back.....	10
Figure 4. Overview of the PILATUS 100K detector system setup.....	13
Figure 5. Principle of direct detection. Contrary to what is illustrated, x-rays normally impinge on the lower surface.....	14
Figure 6. Diagram of a bump bonded hybrid chip.	14
Figure 7. A module, the fundamental unit of every DECTRIS detector.	15
Figure 8. Normal operation with TVX and Camserver on one computer.....	16
Figure 9. Operation with TVX and Camserver on separate computers.....	16
Figure 10: TVX communication scheme	17
Figure 11. TVX control and analysis layout schematic.....	17
Figure 12. Shell showing the active path and the runtvx command.	22
Figure 13. Screen after <i>runtvx</i> has initialized the detector and opened the Camserver and TVX window.....	23
Figure 14. Relevant directories and folders.	24
Figure 15. The 'menu' of TVX.	25
Figure 16: Example of a the butterfly selection tool	31
Figure 19. Value of $V_{comp}(x)$ and mean number of counts per pixel (y).	38
Figure 20. Calibration curve for different amplifier settings V_{rf}	39
Figure 21. Block diagramm of the CMOS read out chip.....	40
Figure 22. Result of the V_{cmp} scan.....	42
Figure 23. Result of the V_{trm} scan.....	43
Figure 24. Oscilloscope trace of an external trigger. See text.....	49
Figure 25. Delay and jitter.....	50
Figure 26. Oscilloscope image of an external enable.	51
Figure 27. Oscilloscope trace of the typical delay between enable signal and exposure.....	51
Figure 28. Oscilloscope image of the multiple exposure mode.....	52